

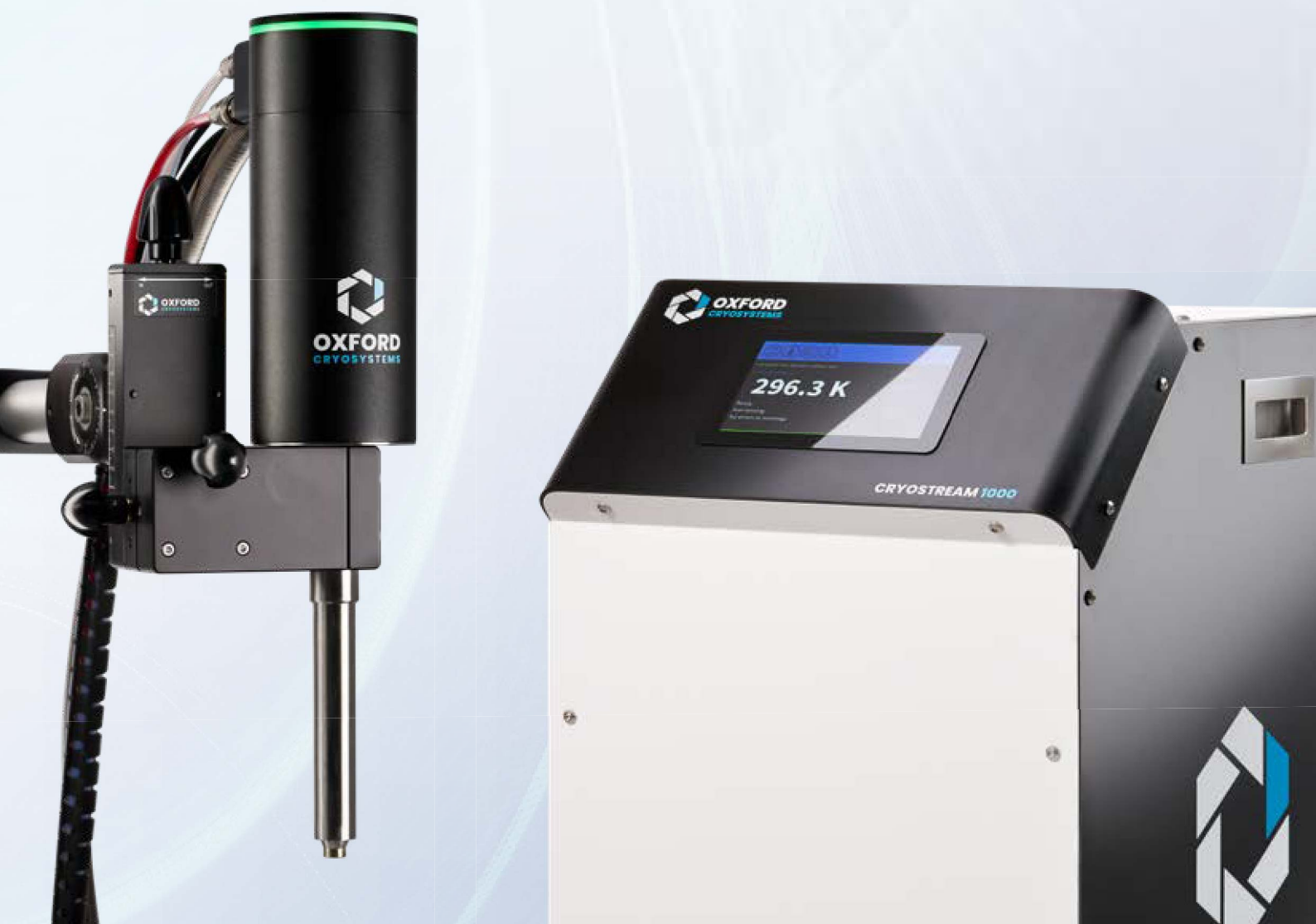

CRYOSTREAM 1000



USER GUIDE & MANUAL

V2.2



Setting up your Cryostream has never been easier. Whether you're new to the system or just need a quick refresher, our comprehensive video series guides you through the entire installation process.

[Scan the QR code to get started](#)

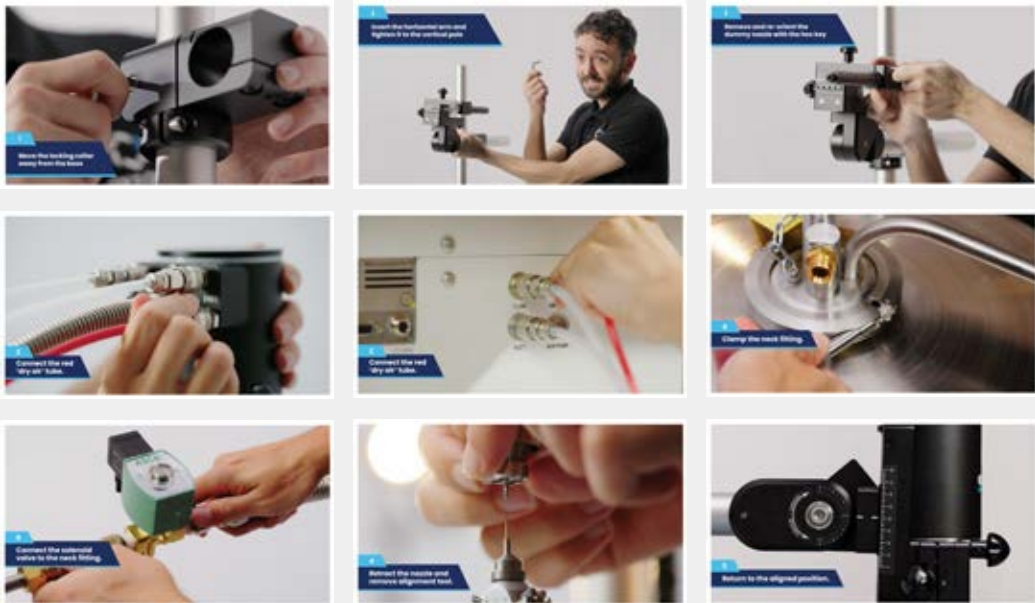

TABLE OF CONTENTS

1	Safety Conventions.....	3
1.1	Safety Symbols	3
1.2	Personnel Qualifications	3
2	Liability and Warranty	4
2.1	Registration.....	4
3	Safety Information.....	5
3.1	General Safety and Environmental Use.....	5
3.2	Use of System around X-rays.....	6
3.3	Use of Dewar	6
3.4	Refilling.....	7
3.5	Contact with the Stream of Nitrogen Gas.....	8
3.6	Automated Liquid Nitrogen Refill System	8
4	Outline of Intended Use.....	9
4.1	Improper Use	9
5	Technical Data	10
5.1	Standard Cryostream Technical Data	10
5.2	Alternative Cryostream transfer line options.....	11
6	Setting Up the Cryostream.....	12
6.1	Before you Begin.....	12
6.2	Cryostream Set Up – Overview.....	13
6.3	Stage One - Varibeam Set up.....	14
6.4	Stage Two - Handling of Cryostream Coldhead and Transfer Line	20
6.5	Stage Three - Cryostream Dewar Vessel.....	21
6.6	Stage Four – Positioning 1000 Series Gas Supply Module	22
6.7	Stage Five - Cable and Tube Connections	23
6.8	Cryostream Nozzle Alignment.....	27
6.9	Temperature at the Crystal Position	27

7	Programming the Cryostream 1000 Series Cryostream	28
7.3	Command Screens and Settings Menus	37
7.4	Information Screens	40
7.5	Errors and Warnings on the Gas Supply Module (GSM)	41
8	Maintenance.....	42
8.1	Service Intervals.....	42
Appendix 1	Remote control and monitoring of the Cryostream	44
Appendix 2	Cryostream Troubleshooting Guide	50
Appendix 3	Pumping down the vacuum space in the Cryostream.....	60
Appendix 4	Repairs and Returns Procedure	65
Appendix 5	Liquid and Gaseous Nitrogen Safety Sheet.....	67
Appendix 6	The Autofill (Automated LN2 Refill)	71
	Introduction	71
	Components of the autofill	72
	Calibration and Set Points	74
	Before Getting Started.....	74
	Setting Up.....	75
	Features.....	76
	Operation	77
	Maintenance.....	81
	Autofill Status Screen Fault Codes.....	83

1 SAFETY CONVENTIONS

1.1 SAFETY SYMBOLS



DANGER

Information displayed under this heading must be conformed to in order to avoid death or serious injury.



WARNING

Information displayed under this heading relates to the prevention of equipment and/or environmental damage.



CAUTION

Information displayed under this heading relates to correct handling or use of the equipment. Disregarding these instructions or cautions can lead to malfunctions or minor equipment damage.

NOTE

Information displayed under this heading provides useful and helpful tips.

1.2 PERSONNEL QUALIFICATIONS



SKILLED PERSONNEL

All tasks described in this document may only be carried out by persons who have received suitable technical training within the necessary field of expertise, or who have been correctly and fully instructed by the custodian of the product.

2 LIABILITY AND WARRANTY

Oxford Cryosystems assumes no liability and the warranty becomes null and void if the custodian or third parties:

- disregard the information in this document.
- use the product in a non-conforming or improper manner. Please refer to section 4.1 as to what deems “improper use.”
- make any kind of changes (modifications, alterations etc.) to the product.
- use the product with accessories not listed in the product documentation.

The custodian assumes the responsibility in conjunction with the documentation and media supplied.

For further information on liability and warranty terms, please refer to Oxford Cryosystems terms of sale - <https://terms.oxcryo.com/warranty>.

2.1 REGISTRATION

In order for Oxford Cryosystems to be able to provide an efficient and effective service, you should register your system with us. The most convenient way to do this is by creating an account on Oxford Connect (connect.oxcryo.com) which has the added advantage of allowing you to monitor and control your Cryostream system remotely.

Visit connect.oxcryo.com for further details.

3 SAFETY INFORMATION

3.1 GENERAL SAFETY AND ENVIRONMENTAL USE

The 1000 Series Cryostream unit (consisting of the Gas Supply Module and Coldhead), is designed to be operated within the following environmental conditions:

- Environmental Temperature Range: 15°C to 35°C
- Relative Humidity: 10 - 70%

In addition to the above, please ensure the following safety conditions are followed:

- The equipment should not be placed close to any source of potential water leak or spillage. The Gas Supply Module must also be operated well away from the possibility of any splashes from liquid nitrogen.
- The Gas Supply Module must be connected to an earthed power supply.
- The Reactivation Heater **MUST** be powered from the Gas Supply Module using the cable supplied and **NEVER** connected independently to mains supply.
- Ensure that all vents around the Gas Supply Module are kept clear during usage to prevent any overheating and damage to the system.
- It is important that the mains power cable to the back of the Gas Supply Module and access to the isolation switch are kept clear and unobstructed to the user at all times.
- The mains power cable used shall be appropriately rated and approved according to the regulations of the country of use.
- Ensure that all 4 wheels of the Gas Supply Module are secure / correctly fitted and once the unit is installed its final position, ensure that the brakes on the front 2 wheels are locked. When transporting the Gas Supply Module in its shipping crate, always ensure that the front 2 wheels are locked before closing / tightening the panels on the crate.

3.2 USE OF SYSTEM AROUND X-RAYS



DANGER

The Cryostream is designed for use with an X-ray system for the purposes of cooling crystalline samples for study by X-rays. In order to safely use the Cryostream within this environment, it is assumed that all users are trained in and certified to local X-ray safety standards and that all necessary precautions have been taken with respect to X-ray safety when both installing and using the Cryostream system. Oxford Cryosystems cannot accept responsibility for technical issues or equipment damage which arises through improper use of third-party equipment (or unsafe installation) with respect to X-rays.

Liquid Nitrogen Handling



DANGER

When using the Cryostream system it will be necessary to refill the Dewar vessel with liquid nitrogen. It is assumed that all users have had local safety training in the handling and transport of liquid nitrogen. Liquid nitrogen for use with the Cryostream should not be handled by anyone who has not received the correct training or is not authorised to do so by the local Health & Safety Officer.

NOTE

Please refer to Appendix 5 Liquid and Gaseous Nitrogen Safety Sheet.

3.3 USE OF DEWAR



WARNING

The Cryostream system has been designed to be used with unpressurised Dewar vessels supplied by Oxford Cryosystems. Under no circumstances should the supplied Dewar vessel be sealed or pressurised in any way. Whilst the system can be used with a variety of unpressurised Dewar vessels, Oxford Cryosystems accepts no responsibility should there be any detriment to the performance when using alternative vessels, sourced through third parties or otherwise, and accepts no liability should there be any damage caused to the Cryostream system, third party systems or personnel. Damage caused in this way immediately voids any warranty.

3.4 REFILLING



DANGER

Refilling of the Cryostream Dewar should only be carried out by someone trained in the handling of liquid nitrogen.

3.4.1 Points of Consideration when Refilling the Dewar Vessel

- Ensure the operator has had appropriate training and is wearing the relevant Personal Protective Equipment (PPE) as specified during the training.
- If the Dewar is being refilled manually, make sure the nozzle of the liquid nitrogen supply transfer line is inserted at least 30cm inside the neck of the Dewar.
- Do not push the nozzle of the transfer line down into the liquid (to submerge it) as this can cause excessive boil off and liquid turbulence.
- Slowly open the supply valve from the self-pressurised vessel to prevent sudden surging of liquid nitrogen. Note that the liquid will not flow straight away as the transfer hose from the self-pressurised vessel to the Cryostream Dewar will need to be cooled first.
- Do not leave the Cryostream Dewar unattended during refilling operations at any time.
- Do not allow the Cryostream Dewar to overflow.
- Once the Cryostream Dewar has been filled, cover the vessel with the cap provided to prevent atmospheric moisture migrating inside.



WARNING

The Cryostream Dewar should be refilled from a secondary self-pressurised storage Dewar. The pressure in the self-pressurised storage Dewar must not exceed 2 bar. Highly pressurised vessels can cause excessive turbulence of the liquid nitrogen within the Cryostream Dewar resulting in the system shutting down.

3.4.2 Refilling of Dewar within the X-ray Enclosure

If the Cryostream Dewar has been installed inside the X-ray enclosure, boil-off from the refilling process could fill the enclosure with vapour. To keep this vapour to a minimum, ensure the pressure in the self-pressurised storage vessel is kept as low as possible; preferably not exceeding 1 bar, and consider venting the Dewar outside the enclosure.

3.5 CONTACT WITH THE STREAM OF NITROGEN GAS

Although the Cryostream produces a stream of cryogenic gas, the amount of cooling is relatively small so short exposures from the stream on the surface of the skin are unlikely to cause any injuries. However, prolonged skin exposure to the stream at low temperatures (or high temperatures in the case of the Cryostream Plus) may result in skin burns.

3.6 AUTOMATED LIQUID NITROGEN REFILL SYSTEM

The 1000 Series Cryostream can be used in conjunction with its Integrated Automatic Liquid Nitrogen Refilling System. This system is designed to measure the level of the liquid in the Dewar and to refill it. Refilling of the Cryostream Dewar is initiated once the level of the liquid inside drops below a predefined level and then stops once an upper level is reached. This is achieved by controlling a solenoid valve on the liquid nitrogen supply transfer line between the self-pressurised storage vessel and the Cryostream Dewar.

See **Appendix 6 Setting Up and Using the Integrated Automatic Liquid Nitrogen Refill System** for further details.



WARNING

Oxford Cryosystems accepts no responsibility or liability for automatic refill systems that are left unattended. Do not leave the system unattended at any time.



DANGER

An appropriate oxygen sensor should be installed in the room where the autofill system is being used with a pressurized dewar.

3.6.1 Automatic Refill Liability

Oxford Cryosystems accepts no responsibility or liability for damage to equipment or injury to any persons caused by either the misuse of the automatic refill system or any of its component parts. Oxford Cryosystems has designed, built and supplied the system in good faith but the user installs and uses the system at their own risk. The user should only operate the system in 'Automatic mode' while someone is in attendance. If the unit is left unattended in Automatic mode, e.g. overnight, the user does this at their other risk.

4 OUTLINE OF INTENDED USE

The Cryostream is designed:

- To be used with liquid nitrogen only.
- For use with an unpressurised Dewar vessel. The Cryostream 1000 (or any previous model) must never be inserted into a pressurised Dewar vessel.
- To cool a sample of less than 1mm³ in an open stream of gas. The nozzle is not designed to be enclosed or to cool samples that are enclosed inside any kind of sample holder, chamber or vessel.
- To be used with the components and accessories supplied with the system or purchased separately through Oxford Cryosystems. Use of accessories not outlined in this manual can only be used expressly with the written agreement of Oxford Cryosystems.

4.1 IMPROPER USE

Improper use of the system will forfeit claims for liability and any warranties on the system. Improper use would include:

- Not using the product as described within this technical guide
- Using the product with other liquids or liquid gases other than liquid nitrogen
- Inserting the Cryostream into a pressurised Dewar vessel
- Using the system when not authorised to do so or without the correct training
- Using support stands other than the Varibeam Support Stand, unless prior authorisation from Oxford Cryosystems has been given
- Using a different dry air system without prior authorisation from Oxford Cryosystems
- Any attempt to modify or exchange parts or components within the system with non-standard parts that have not been supplied by Oxford Cryosystems

5 TECHNICAL DATA

5.1 STANDARD CRYOSTREAM TECHNICAL DATA

1000 Series Cryostream Coldhead	
Temperature Range	80-400 Kelvin (or 80-500 Kelvin for Cryostream Plus)
Nitrogen Gas Flow Rate	5 or 10 litres/minute
Liquid Nitrogen Consumption	0.6 litres/hour at 5 litres/minute gas flow 1.2 litres/hour at 10 litres/minute gas flow
Temperature Stability	0.1 Kelvin
Cool Down Time to 100 Kelvin	20 minutes
Standard Length of Transfer Line	1500 mm (see section 5.2)
1000 Gas Supply Module	
Dimensions & weight	406 mm W x 863 mm H x 526 mm D, 75 kg
Mains power supply	100-120V 50/60 Hz, 220-240 V 50/60 Hz
Net Fuse	100-120V / 220-240V – 12.5A HBC T Fuse
Power consumption	1000VA
Dry Air	Max 15 L/min Settable in 1 L increments Maximum 1.2 bar pressure
Gas and Pressure	Delivery pressure of 1.1 bar/16 psi Maximum of 10 l/min gas flow Minimum dew point of -70°C High purity nitrogen gas
Varibeam Support Stand	
Max. table to sample height (Cryostream vertical)	600 mm
Max. horizontal distance to sample from Varibeam column (Reach)	430 mm
Weight	6 kg

ES60 Dewar vessel	
Volume	60 litres
Construction	Welded stainless steel
Overall dimensions	725mm H x 457 D (650 mm Internal Depth)
Weight	36 kg empty, approx. 96 kg full
Neck size	NW50 KF fitting 50mm diameter bore

5.2 ALTERNATIVE CRYOSTREAM TRANSFER LINE OPTIONS

Cryostream Version	Flexible Length	Rigid Leg Length	Total Length
Standard	1500mm	800mm	2300mm
Long Transfer Line	3000mm	800mm	3800mm

6 SETTING UP THE CRYOSTREAM

6.1 BEFORE YOU BEGIN

6.1.1 Items Supplied

Qty	Description
1	1000 Series Cryostream Coldhead (with integral transfer line)
1	1000 Series Gas Supply Module
1	Power Cable
1	Coldhead Cable (5m)
1	LED Cable (5m)
1	Computer Cable set comprises:
1	Serial Cable for CryoConnector (5m)
1	USB C Cable for CryoConnector (5m)
1	Ethernet Cable for CryoConnector (5m)
1	Tube Set comprises:
2	PTFE Tubes with Fittings (5m)
1	Red PTFE Dry Air Tube with Connector (5m / 6mmOD)
1	Nozzle Alignment Tool
1	Oxford Cryosystems ES-60 L Dewar
1	Dewar Neck Fitting
1	Condensate Bottle

Note: Tube and cable lengths may differ for specialised systems, depending upon the specific system configurations.

6.1.2 Components supplied for maintenance

Qty	Description
1	Reactivation Heater
1	Pump-out Adaptor Pin
1	T25 TORX Screwdriver
1	GSM Service Kit
1	4mm Hex Key

6.1.3 Optional extras

Components
Varibeam Coldhead Support Stand
Automatic Refill System – see Appendix 6

6.2 CRYOSTREAM SET UP – OVERVIEW

Task	Section
Stage One - Varibeam Set up	6.3
	6.4
Stage Two - Handling of Cryostream Coldhead and Transfer Line	
	6.5
Stage Three - Cryostream Dewar Vessel	
Stage Four - Positioning 1000 Series Supply Module	6.6
Stage Five - Cable and Tube Connections	6.7

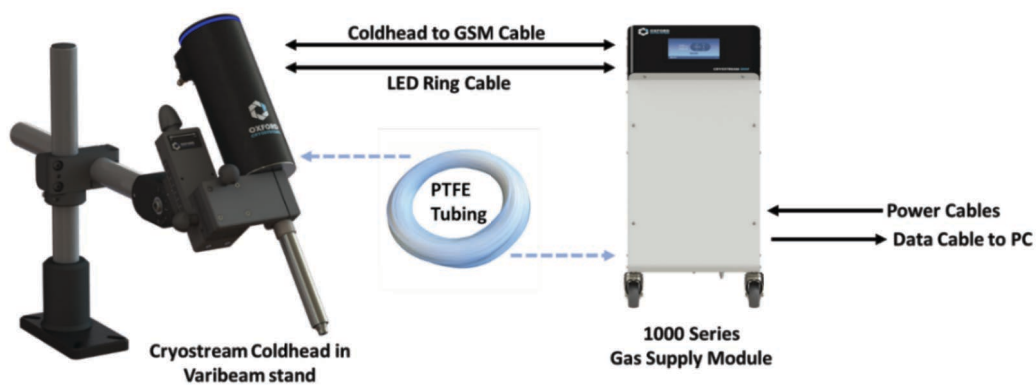

Figure 6.3.1 Schematic diagram of the Cryostream setup

WARNING

Please note this is an overview only, full instructions MUST be read before the system is assembled to avoid causing damage to the system.

6.3 STAGE ONE – VARIBEAM SET UP

6.3.1 Varibeam introduction

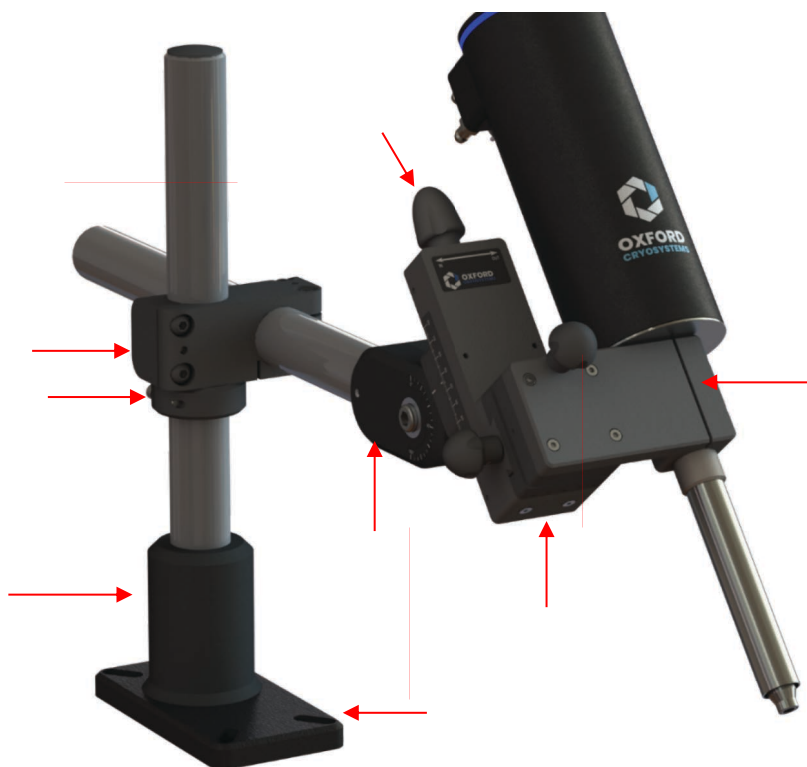

Component	OCS Part number	Description
1	33-90051	Varibeam base plate
2	33-90050	Varibeam base column
3	33-90056	Varibeam height clamp body
4	33-90049	90° Fixing clamp
5	33-90081	Horizontal arm
6	33-90082	Upright column
7	33-90063	Pivot block
8	33-90067	Translation slide
9	33-90058	Adjustment Knob A – Vertical
10	33-90052	Cryostream Coldhead clamp
11	33-90068	Adjustment Knobs (Pair)– B –Horizontal
12	33-90068	Adjustment Knobs (Pair)– C – Tilt

The Varibeam is an extremely robust and rigid stand that will support the Cryostream coldhead on almost all x-ray systems. The Varibeam has a leadscrew positioner that allows the coldhead nozzle to be positioned very accurately at the crystal and then retracted along a scale when access is required. This facility is often very useful where accurate and repeatable alignment is important.

The stand can be assembled in various configurations; the rotation of the horizontal arm; angling the nozzle between 20° and 90°; and the block gripping the cryostream coldhead can be removed and fitted onto the other side of its support plate. This stand will support and guide the Coldhead in all configurations.

6.3.2 Assembling and positioning the Varibeam

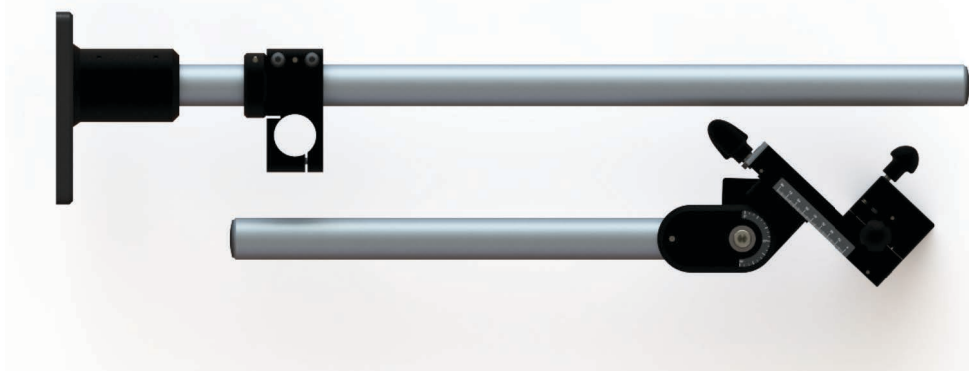

Figure 6.3 Varibeam stand as packed



The Varibeam column and cross-arm are constructed using aluminium which has an extremely robust anodised finish. For packing purposes, the Varibeam support stand is disassembled and will be found as 2 separate pieces. When the stand is being put together, avoid bolting the Varibeam in a position which causes obstruction to the crystal or impinges on any part of the diffractometer / x-ray tube housing.

Using the Hex key provided, move the locking collar (located below the 90 degree block on the vertical pole) to an appropriate height away from the foot, and insert the horizontal arm. Use the Hex key (in the opposite direction) to tighten the two components together.

For packing purposes, the Black Mounting Pin may be mounted backward in the Varibeam Nozzle Clamp. Remove it using the Hex key supplied and fit it into the Nozzle Clamp the right way around. Ensure that the Mounting Pin is pushed all the way into the Varibeam Nozzle Clamp.

If the final positioning of the Cryostream coldhead is not known, it is recommended to install it on a desktop first to allow all options to be considered. Alternatively, use the mounting pin supplied with the support stand as a guide for aligning the eventual position. For determining the exact crystal position, place a fibre in the small hole at the end of the blue Mounting Pin, or use the nozzle alignment tool (available separately, see section 6.8).

The Varibeam is supplied with bolts to allow the user to securely fix the stand to the cabinet tabletop.

Component	Qty supplied	OCS Part number	Description
	4	99-51344	ISO 4762 M6 x 25 mm hex cap bolt
	4	99-51355	ISO 7089 M6 plain washer
	4	99-51353	ISO 4032 M6 nut
	4	99-51356	ISO 4762 M6 x 60 mm hex cap bolt

These fixing screws (or equivalent) should be installed in all four positions of the Varibeam base plate, as shown – for clarity the base column is hidden in this illustration.

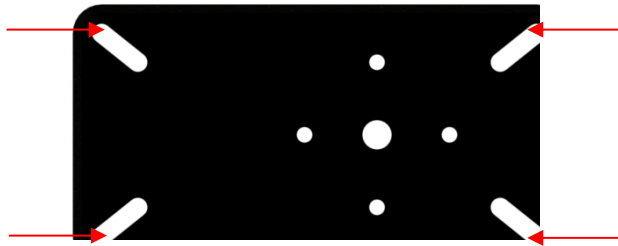

Figure 6.4 Varibeam base plate

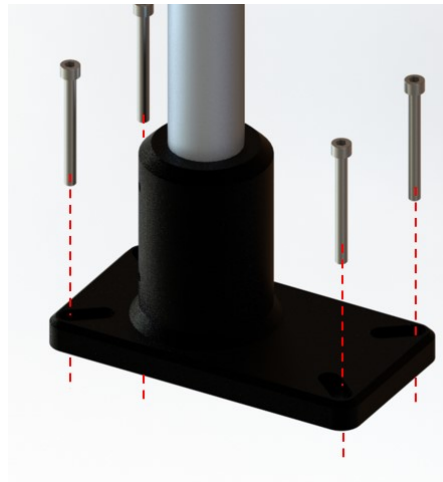

Figure 6.4 Schematic of varibeam base plate

Prior to drilling mounting holes for installation, it is recommended to experiment with various positions first. This can be done by using a G-or C-clamp to temporarily fix the Varibeam to the tabletop. Ensure that the cabinet manufacturers guidelines are properly observed when considering any modifications for fixing bolts. OCS cannot accept any liability for the warranty of third-party equipment, which may be invalidated as a result of drilling fixing holes.

6.3.3 General guidelines for mounting the Cryostream coldhead

The Varibeam weighs 6kg and is unwieldy when assembled, use the Mounting Pin supplied with the Varibeam rather than the Coldhead as a guide for aligning the nozzle. Once the Mounting Pin has been aligned to the sample position, it can be removed from the Varibeam and the Cryostream Coldhead put in its place.

The pivot block and translation slide have two sets of measurement indicators, which combined with knobs A...C, allow the user to perform fine adjustments in the position of the coldhead. The range of adjustment is shown in the table below.

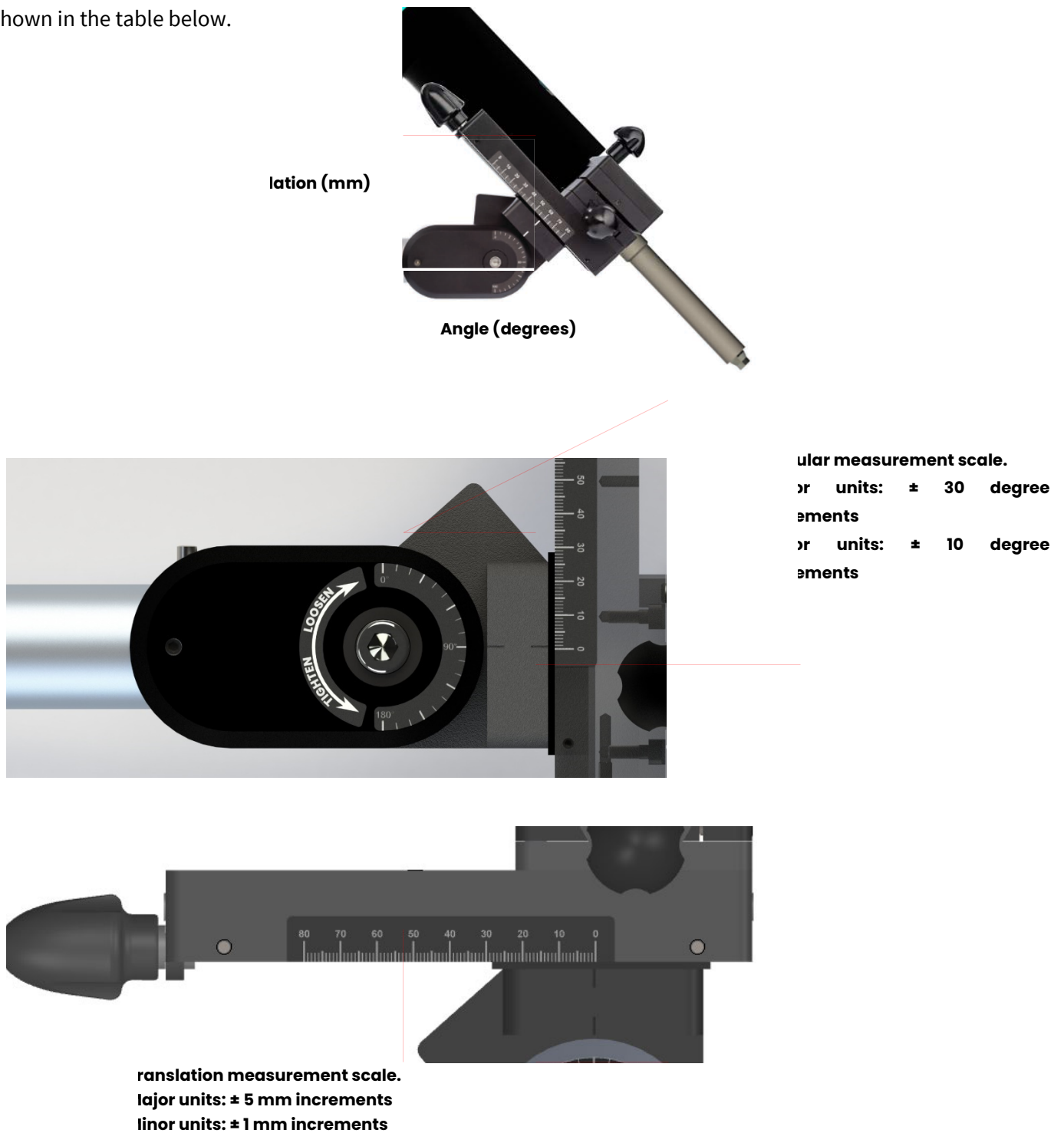

Figure 6.5 Varibeam Adjustment points

	Min	Max
Vertical distance: Mounting surface to sample position	0 mm	600 mm
Horizontal distance: Varibeam column to the sample position	0 mm	430 mm
Angular adjustment range	+20°	+90°

There are some general rules which should be considered when mounting the Varibeam in position and then fitting the Cryostream Coldhead in place:

- Do not fix the stand to the cabinet top so it prevents access to the X-ray tube, restricts the detectors movements or makes access to the crystal difficult.
- It is not necessary to perfectly align the nozzle of the Cryostream in place when locating and fitting the Varibeam. The fine X, Y and Z translations of the stand allow for accurate alignment once the stand is in place.
- Do not direct the nitrogen cold stream at the X-ray detector.
- Try to limit the amount that the end of the Cryostream gas delivery nozzle infringes the path of the X-rays.
- Do not point the cold stream so that it is cooling any optical devices or gearing (these devices need to be more than 15 cm away).
- The crystal should be less than 8 mm from the end of the Cryostream nozzle (optimum distance is 5 mm) in the centre 2 mm of the gas stream; this will help to prevent icing. The Oxford Cryosystems Nozzle Alignment Tool is ideal for determining the correct position.
- Make sure that when the Cryostream Coldhead is fitted into the Varibeam, the Transfer Line can reach the bottom of the Cryostream Dewar vessel

The Varibeam is supplied with a kit of nuts and bolts to fit in the slotted base allowing the user to securely fix the stand to the enclosure table top or hang securely from the roof of the enclosure, if appropriate.



WARNING

Always use the Locking Collar to support the Horizontal Arm in the 90 degree block to ensure it does not slip when the Arm is loosened.

6.4 STAGE TWO – HANDLING OF CRYOSTREAM COLDHEAD AND TRANSFER LINE

Please ensure that;

- a) The rigid section of the Cryostream Transfer Line can be fed through a port in the cabinet or labyrinth (if applicable).



DANGER

Please ensure that any ports made in your cabinet adhere to your local Health and Safety laws and policies and have been approved by your local Health and Safety Officer and the original enclosure manufacturer.

- b) The rigid section of the Cryostream Transfer Line can be fed into and reach the bottom of the Dewar. The Cryostream Coldhead is designed to be fitted into the Nozzle Clamp of the Varibeam. Make sure the Cryostream Coldhead is pushed all the way into the Nozzle Clamp before tightening the bolts on the Nozzle Clamp. It might be necessary to retract the nozzle using the Z-motion of the Varibeam stand so that it doesn't interfere with the pre-aligned crystal position.

NOTE

Use the Z-translation on the Varibeam to retract the nozzle from the crystal position. Do not move the Cryostream Nozzle by sliding out of the Nozzle Clamp.



CAUTION

It is important to handle the Cryostream Coldhead and transfer line assembly as carefully as possible.

- The minimum bend radius of the transfer line is 200mm. Do not bend the flexible line more tightly as this will result in possible damage of the internal capillary.
- Try to avoid turning the rigid part of the transfer line upside down.
- Do not try to disconnect the flexible transfer line from the Coldhead. This will cause a loss of vacuum and will damage the system.
- During use, do not remove the rigid leg section from the Dewar until the Cryostream Coldhead is warm. If the rigid leg needs to be removed more quickly from the Dewar, program a PURGE.

6.5 STAGE THREE – CRYOSTREAM DEWAR VESSEL

Fill the Dewar with liquid nitrogen.

The purpose of the Dewar vessel is to hold the liquid nitrogen to be used by the Cryostream. The ES Dewar vessels supplied by Oxford Cryosystems have been designed specifically for use with the Cryostream. Other Dewars can be used with the Cryostream, however, Oxford Cryosystems does not take responsibility for other Dewar vessels or their suitability.



DANGER

Section 3 of this document refers to the safety aspects of the handling of liquid nitrogen. It is assumed that these instructions and guidelines have been followed. Do not, under any circumstances, handle liquid nitrogen unless authorised and suitably trained to do so by the local Health & Safety Officer. Further safety information on the handling of liquid nitrogen can be found in *Appendix 5 Liquid and Gaseous Nitrogen Safety Sheet*.

If a Dewar other than the ES60 is being used, be aware of the following points:

- Capacity – The recommended capacity is between 30 and 60 litres. Smaller Dewar vessels will require refilling more often than larger Dewar vessels. This will result in greater boil off during refilling and, therefore, a greater overall consumption of liquid nitrogen.

NOTE

When considering a large Dewar, it is important to remember that the rigid transfer line of the Cryostream is plunged into the Dewar and is ~800 mm long, so it can only utilise the top 750 mm of a Dewar vessel. It is possible to use a 100 L Dewar, but if the rigid transfer line does not reach the bottom, the Cryostream will not utilise the full capacity of the vessel.

- Construction – either stainless steel or aluminium.
- Neck opening size – Dewar necks vary in size. If the opening is too small, there may be problems refilling the Dewar. If the Dewar opening is too large, then the rate of boil off will be very high and contaminants will get into the liquid nitrogen.

6.5.1 Fitting the Cryostream Rigid Transfer Line into the Dewar

It is recommended that the end of the Transfer Line does not sit on the bottom of the Dewar vessel. Generally, particulate matter will concentrate in the bottom of the vessel and, although rare, this can block the flow of liquid nitrogen and stop the system.

Because the Cryostream applies the same gas pressure at the crystal as it does in the Dewar, it is safe to replenish the supply of liquid nitrogen to your Dewar at any time without any fluctuations in gas temperature. This can be done manually or by using the Oxford Cryosystems automatic refilling system.

NOTE

Please ensure that the Dewar is at least ~20% full at all times.

6.6 STAGE FOUR – POSITIONING 1000 SERIES GAS SUPPLY MODULE

6.6.1 Placement of Module

The 1000 Series Gas Supply Module is designed to manage the Cryostream system. It is important to place the module so the user has easy access to the front panel and can clearly see the display / system status information on the front. As the module is connected to other components in the system, it should be placed less than 5 metres from the Coldhead.



DANGER

Incorrectly placed cables and pipework present a serious risk of tripping. A risk assessment should always be carried out once the Cryostream system has been installed to identify possible hazards. Cables and pipes should be positioned in such a way that users do not have to walk over them. To prevent this, locate electrical items close to a power socket so the cable can be secured along the wall as opposed to the floor. Where the layout is such that the cables or pipes must run along the floor, they must be protected by a 'cable protector' and not simply taped down.

6.7 STAGE FIVE - CABLE AND TUBE CONNECTIONS

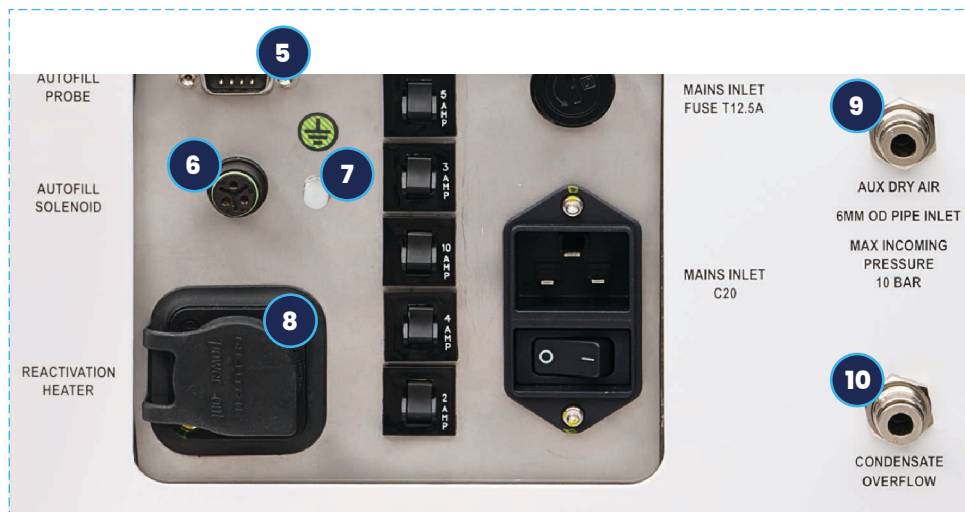
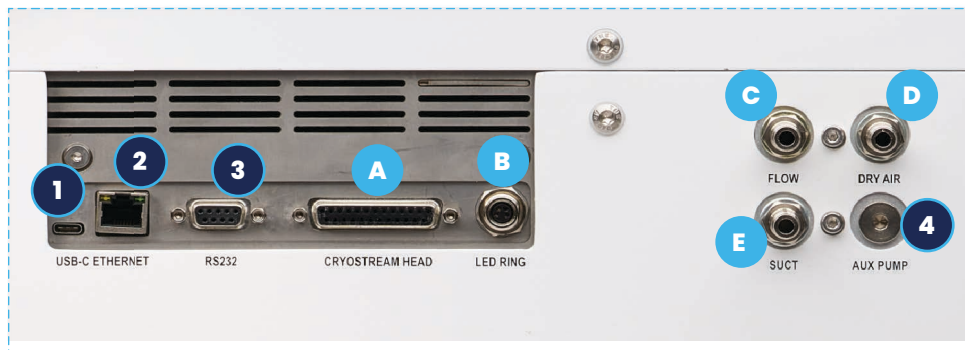

6.7.1 Connecting the Gas Supply Module to the Coldhead

	Connection	From	To Coldhead
A	Coldhead Cable	'Coldhead' socket on GSM	Electrical socket
B	5m white LED ring cable	'LED RING" connector on GSM	LED ring connector
C	5m white tubing with connectors	'FLOW' connector on GSM	FLOW connector
D	Red dry air tubing	'DRY AIR' connector on GSM	Dry gas connector
E	5m white tubing with connector	'SUCT' connector on GSM	SUCT connector

6.7.2 Additional Connections (Optional)

	Optional Connections	Connector	To
1	USB-C	USB-C cable socket	PC
2	Ethernet	Ethernet cable socket	PC, network hub or router
3	RS232	9 Way Serial Cable socket	PC (Serial port connection)
4	External Pump	'AUX PUMP' connector on GSM	External Pump
5	Autofill Probe	9 Way Serial Cable	Autofill Capacitance Probe
6	Autofill Solenoid	Autofill Valve cable	Autofill Solenoid Valve
7	External M5 Earthing Stud	M5 Earthing Stud	Grounding Plate
8	Reactivation Heater	Reactivation Heater Cable	Reactivation Heater
9	External Dry Air Source	'AUX DRY AIR' connector on GSM	External Dry Air Source
10	Condensate Overflow	'CONDENSATE OVERFLOW' connector on GSM	Condensate Overflow bottle

6.7.3 In-house Dry Air Supply



WARNING

Failure to turn off the internal dry air unit when using external dry air can result in critical damage to Cryostream 1000 GSM.

The cold nitrogen gas stream requires a shroud of dry air as it exits the nozzle to ensure an ice-free environment on and around the sample while at low temperatures. The GSM has its own air supply unit, and so it is not necessary to use external dry air. We would recommend using the dry air source provided by Oxford Cryosystems. However, in the event of GSM failure, or if it is a strong preference, an external dry air source can be used with the Cryostream.

Users should not plumb in their own dry air unit without first switching off the internal GSM dry air unit. Failure to turn off the dry air unit risks damage of the Cryostream 1000.

If using external dry air, the gas should have:

- A dew point of less than -60°C
- Regulated delivery pressure of 1 bar /14.5psi (Max. 1.4 bar /20.3psi)
- A minimum of 12 L/min gas flow

Use the 5m length of 6mm diameter tubing provided to connect your dry air source to the Cryostream using 'AUX DRY AIR' port.

The Cryostream Gas Supply Module is provided with a separate condensate bottle. With the dry air, there is the chance that it will produce excess water which can spill from the condensate overflow port of on the rear of the unit. Please fit the bottle to the port to prevent unexpected spillages.



Figure 6.7 Aux dry air port location

6.7.4 External Earthing Stud

The Gas Supply Module features an external M5 earthing stud on the back of the device. This stud comes with nut, shake-proof washer, plain washer, and protective cap. Cryostream 1000 users may utilise this stud to provide an additional common earth connection where required.



Figure 6.8 Earthing Stud Location

To use the additional earthing stud:

1. Remove the protective cap from the stud, along with the nut and washers.
2. Install the additional earthing wire using an M5 sized ring terminal (for wire, minimum 2.5mm² cross-sectional area / 14 AWG is recommended).
3. Next, place the plain washer onto the stud.
4. Then, place the shakeproof washer onto the stud.
5. Finally, secure the connection by fastening the nut onto the stud.
6. Perform an earth continuity check using a portable appliance tester (PAT) or similar ensures a reliable earthing connection.

6.8 CRYOSTREAM NOZZLE ALIGNMENT

The Nozzle Alignment Tool has been designed to allow the exact centring of a crystal sample in the nitrogen gas stream. Accurate alignment of the stream is vital to avoid ice formation, as it ensures that the crystal stays in the coldest part of the stream as it rotates.

1. Correctly align and centre an example crystal or empty loop as normal by using the adjustments on the goniometer head and telescope or camera crosshairs to focus sharply on the crystal's position.
2. Remove the sample and fit the Nozzle Alignment Tool to the end of the nozzle and tighten the thumb screw to hold it in place.
3. Use the Varibeam Coldhead Support Stand to adjust the position of the Cryostream so the tip of the point of the Nozzle Alignment Tool is in focus at the centre of the crosshairs.
4. Carefully remove the Nozzle Alignment Tool as soon as the nozzle is aligned. The point of the Nozzle Alignment Tool corresponds to the ideal distance the crystal should be from the end of the Cryostream nozzle.



WARNING

- Care should be taken when handling pointed objects.
- Please ensure the Nozzle Alignment Tool is stored appropriately.

6.9 TEMPERATURE AT THE CRYSTAL POSITION

In contrast to other cooling systems (and indeed some previous versions of the Cryostream), the Cryostream displays the gas temperature at the position of the crystal, rather than at a point within the Coldhead. Oxford Cryosystems has established a method of mapping the true temperature at a distance of 5 mm from the end of the nozzle. The superior laminar flow of the Cryostream gas stream allows the user to place the sample up to 8 mm from the end of the nozzle, although 5mm is recommended as the optimum position.

The correction which is applied is a function of gas flow, which means that switching between Normal and Turbo flows will cause a temporary change in the crystal temperature. The Cryostream will compensate for this change. Therefore the reading of "Gas Temperature" on the Cryostream Gas Supply Module, CryoConnector software or Oxford Connect is the true temperature of the nitrogen gas at the crystal position.

7 PROGRAMMING THE CRYOSTREAM 1000 SERIES CRYOSTREAM

7.1 FINAL CHECKS BEFORE SWITCHING ON THE CRYOSTREAM

- Ensure that all the tube and power connections are correctly made.
- Ensure that there is liquid nitrogen in the Dewar and the Cryostream rigid transfer line is in the Dewar vessel.

7.2 STARTING UP THE 1000 SERIES CRYOSTREAM

The 1000 Series Gas Supply Module is switched on using the power switch on the rear of the device. The touch screen will illuminate along with the LED ring on the Cryostream Coldhead. The LED ring will adjust its colour depending on the state of the Cryostream. It will be illuminated according to the table below.

Some of the cooling / heating profiles and example scenarios are explained further in sections 7.2 to 7.5.



Figure 7.1 LED status ring indicator

Colour	Illumination	Cryostream State	Error Condition?
		Power On (shown for 1 second)	
	Fast flash	Start-up mode (in-progress)	
	Slow flash	System ready (Start-up mode complete)	
	Slow flash	Cooling to setpoint temperature	
		Holding at setpoint temperature (below 290 K)	
	Slow flash	Warming to setpoint temperature	
		Holding at setpoint temperature (above 290K)	
	Slow flash	Shutdown	
		End, Purge, Regen phases	
	Fast flash	Start up or Shutdown	Error Condition

7.2.1 Example profile (cooling from ambient to 100 K)

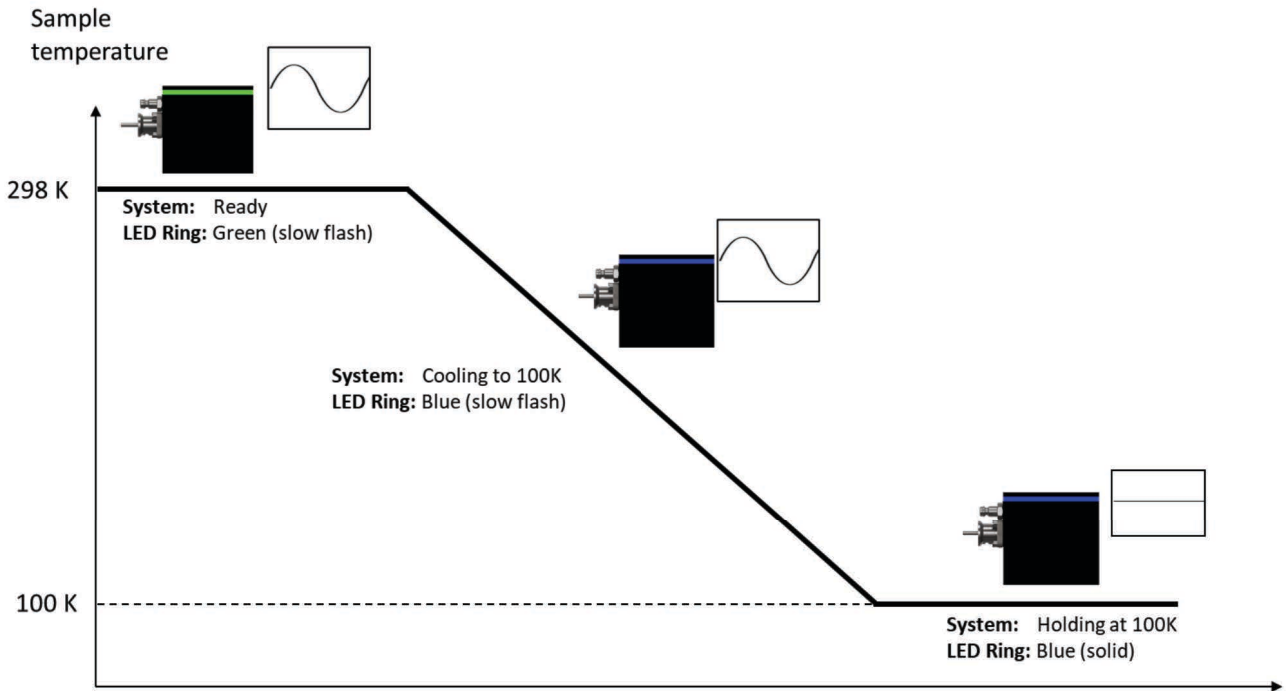

Figure 7.2 Cooling temperature profile

7.2.2 Example profile (warming from 100 K to 200 K)

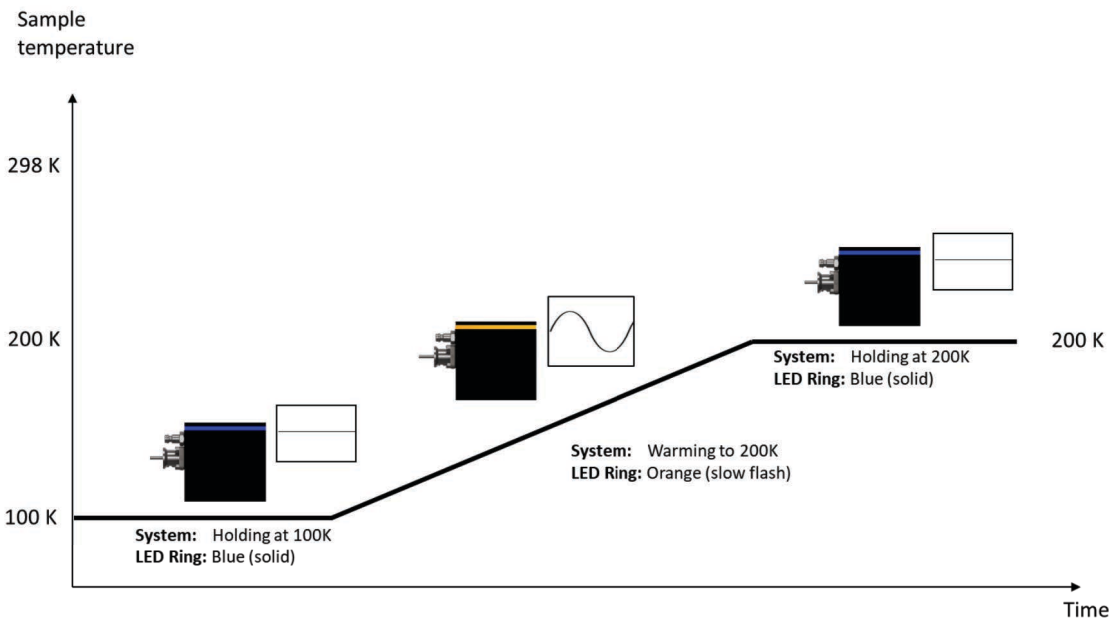

Figure 7.3 Warming temperature profile

Note that since the system is now warming from 100K, the LED ring will flash orange during the heating / ramp phase and then revert to solid blue once the setpoint has been established. If the chosen setpoint is above 290K (see section 7.2.3), the LED ring will revert to solid orange once the setpoint has been established.

7.2.3 Example profile (warming from 100K to 320 K)

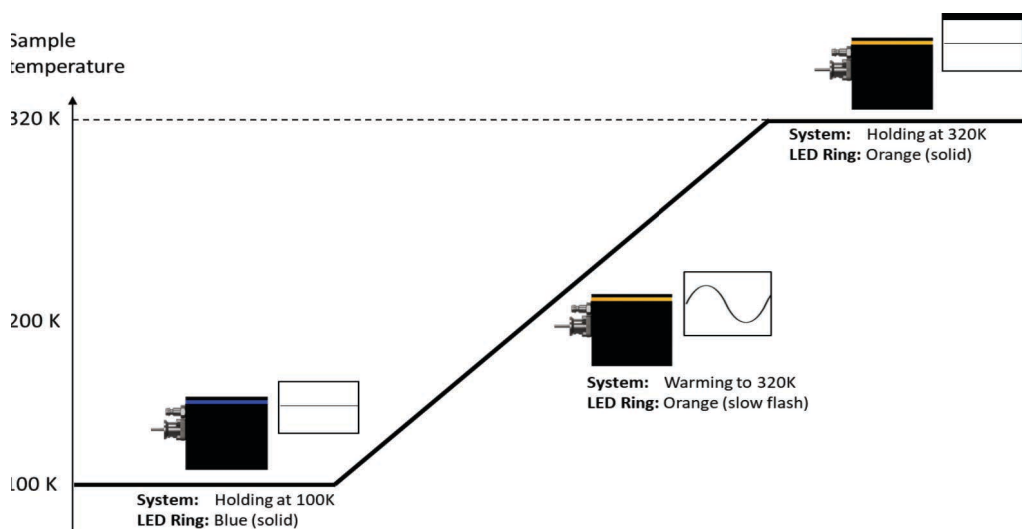



Figure 7.4 Heating temperature profile

7.2.4 The 1000 Series front touch screen is designed to be intuitive and simple to use.



Figure 7.6 Key to 1000 controller home screen

 **Home button:** The blue navigation bar is displayed on every screen within the user interface of the GSM. Pressing the home button at any point will always return the display to the home screen, as shown in Figure 6. If changes are being made to the user defined parameters (e.g. setpoint temperature), the 'OK' button on the applicable screen should be pressed first to action these changes. Pressing the home button without pressing 'OK' will discard any unsaved changes.

 **Command Screens:** Pressing this button opens a subset of menus allowing parameters such as setpoint temperature, ramp rate and ramp mode to be configured.

 **Settings:** Within this menu, more advanced options can be adjusted such as N2 / shield gas flow rates and automatic refill ("Autofill") settings. The end of sequence and shutdown modes can also be chosen.

 **Information:** In certain situations it may be necessary to refer to more detailed information relating to system diagnostics or if errors are reported. This menu has several 'information only' screens which customers may be asked to refer to by a service / technical support engineer.

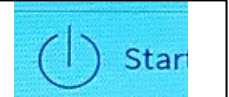
 **Start / Stop / Restart:** This button will start, stop or restart the heating or cooling sequence which is defined within the 'Command Screens' section.

7.2.5 Menu Structure:

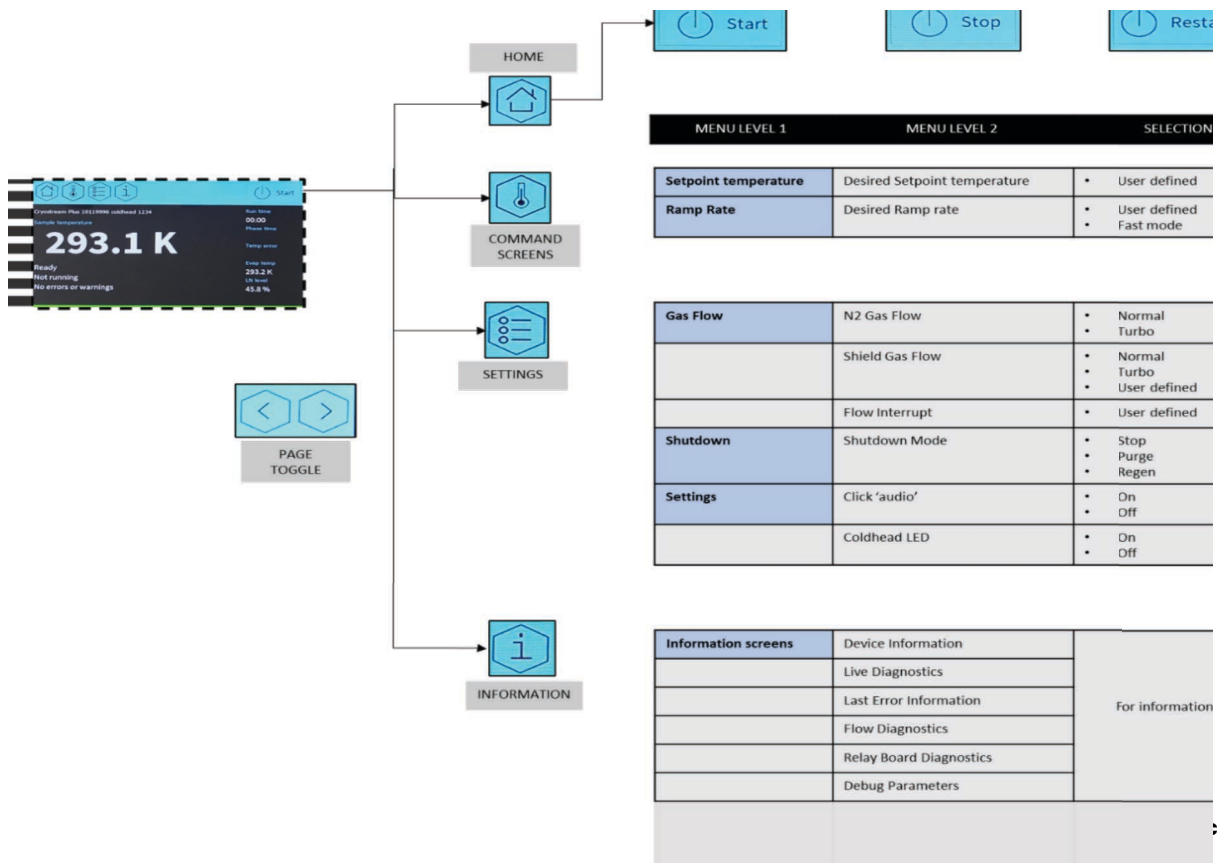

NOTE

Pressing the screen lightly with the fingernail tip gives the best response. The system will produce a brief 'clicking' sound to indicate a touch event has been detected by the display.

7.2.6 Idle Shield Flow Settings

NOTE

Settings: Within this menu, more advanced options can be adjusted such as the N₂/ shield gas flow rates and automatic refill ('Autofill') settings. The end of sequence and shutdown modes can also be chosen

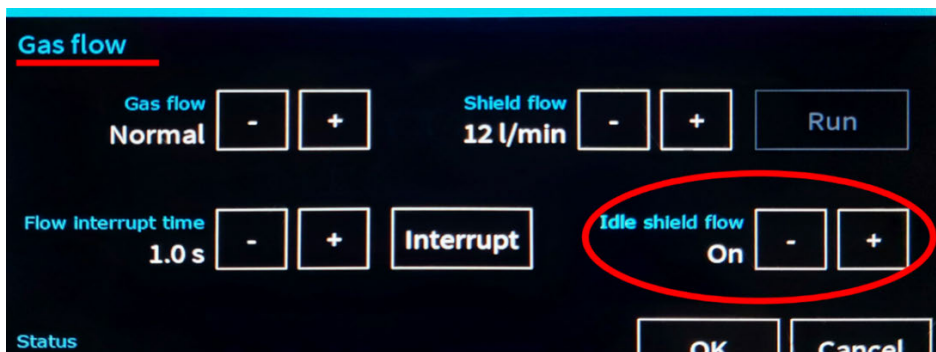
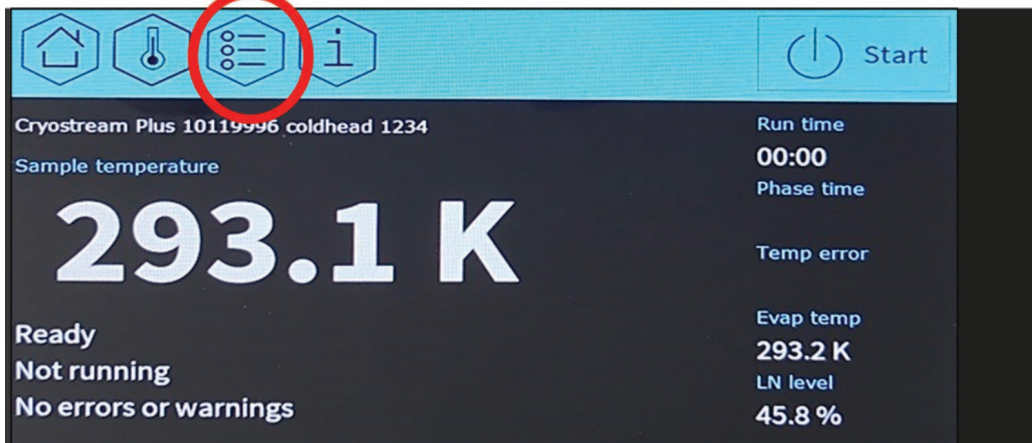

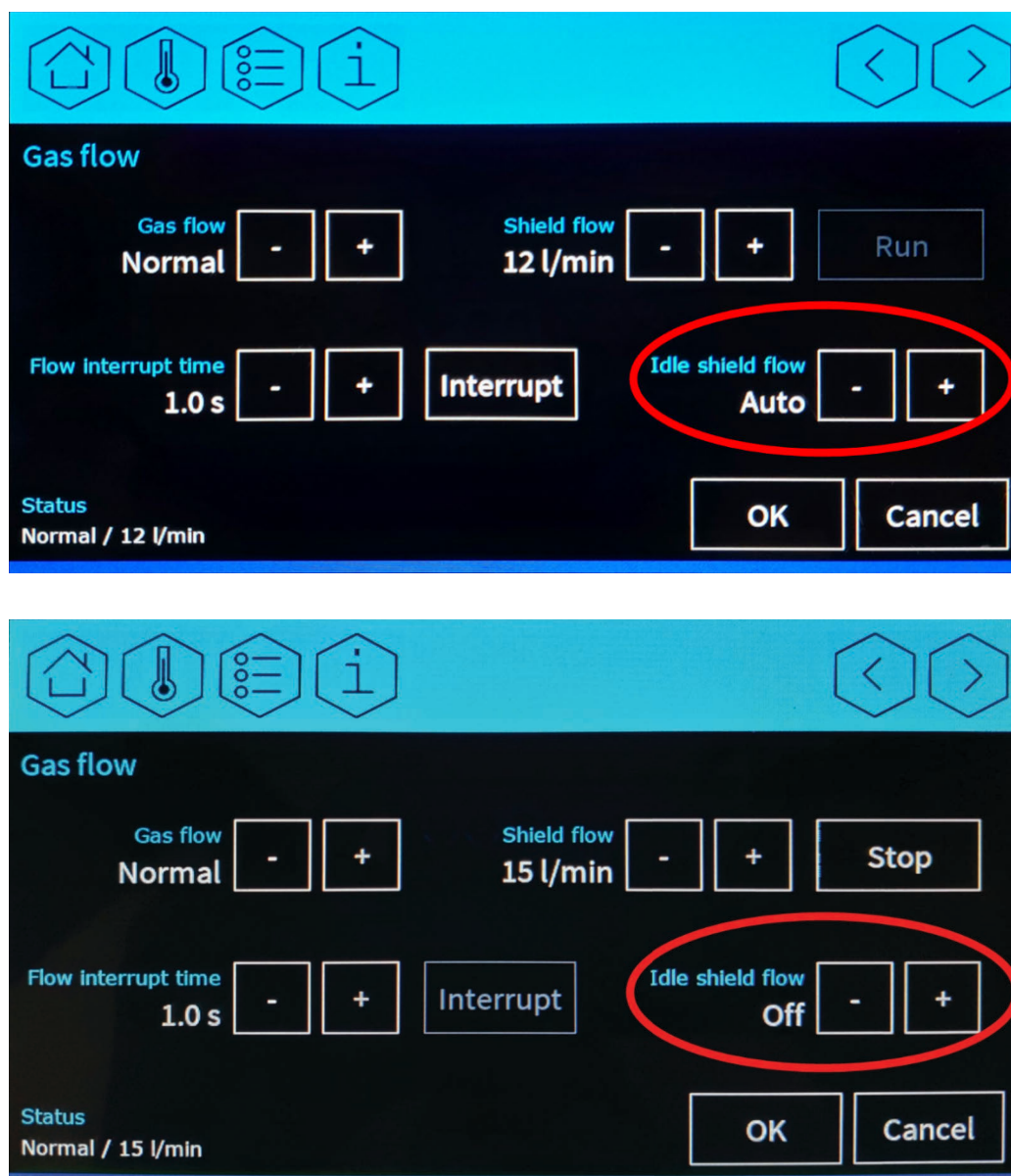

Figure 7.8 Idle Shield flow settings on the controller

Shield flow in the Cryostream is set to avoid ice buildup on the nozzle. To set the shield flow, go to settings and navigate to gas flow. Then select one of the following options using the up and down arrow navigation keys:

- Off : Sets the shield flow and air compressor to permanently off independently of the status of the Cryostream 1000
- On: Sets the shield flow and air compressor to permanently on independently of the status of the Cryostream 1000
- Auto : Shield flow and compressor are on when the Cryostream 1000 is running, and off when the Cryostream 1000 is in shutdown.

7.2.7 Starting a cooling sequence

NOTE



The system status indication and colour bar will be synchronised to the LED ring (see section 7.2 for example scenarios).

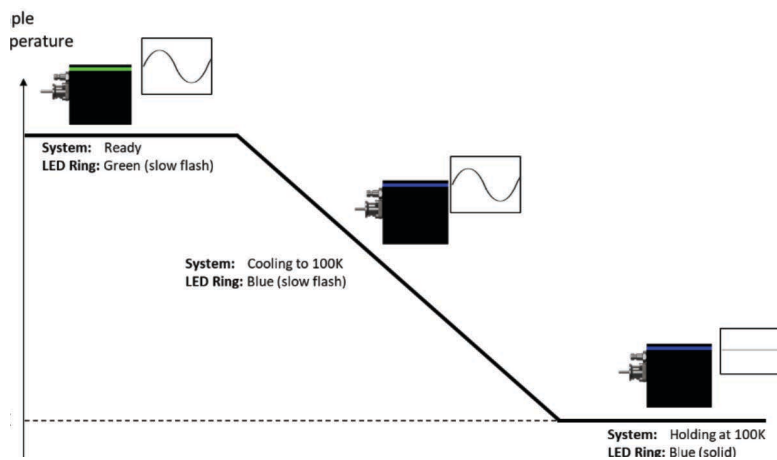
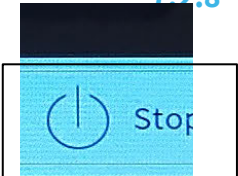

Figure 7.9 Home screen when running

A sequence may be started by pressing the Start/Stop button, and this will execute the command indicated by the Current command text (in this example “Cool to 100.0 K”).

Once the Cryostream is running the Home screen will appear as below. The lower section of the screen will display an indicator bar which will mirror the appearance of the LED ring on the Cryostream head.

7.2.8 Stopping the Cryostream



The Cryostream may be stopped at any time by pressing the Stop button, at which point the Home screen will be presented as shown. Pressing the Start/Stop button once again will initiate the self-check routine and return the controller to the Ready state.

Start button

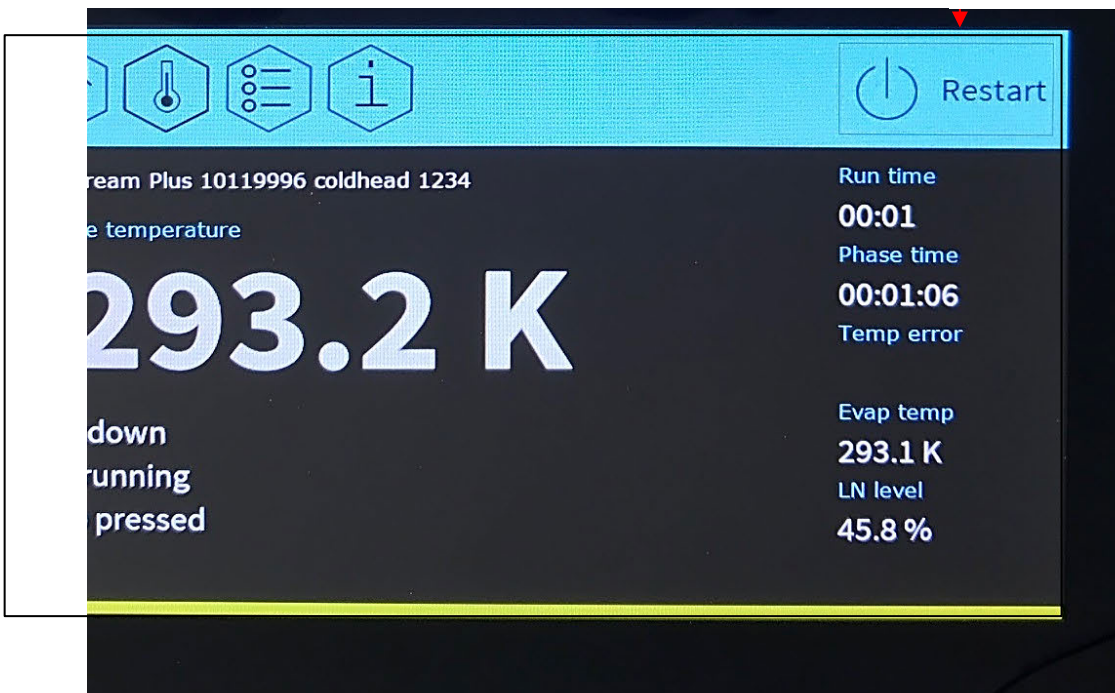

NOTE

7.3 COMMAND SCREENS AND SETTINGS MENUS

7.3.1 Changing the Set temperature and Ramp rates

This screen is accessed by pressing the Command Screens button from the Home screen – which appears as a thermometer icon.

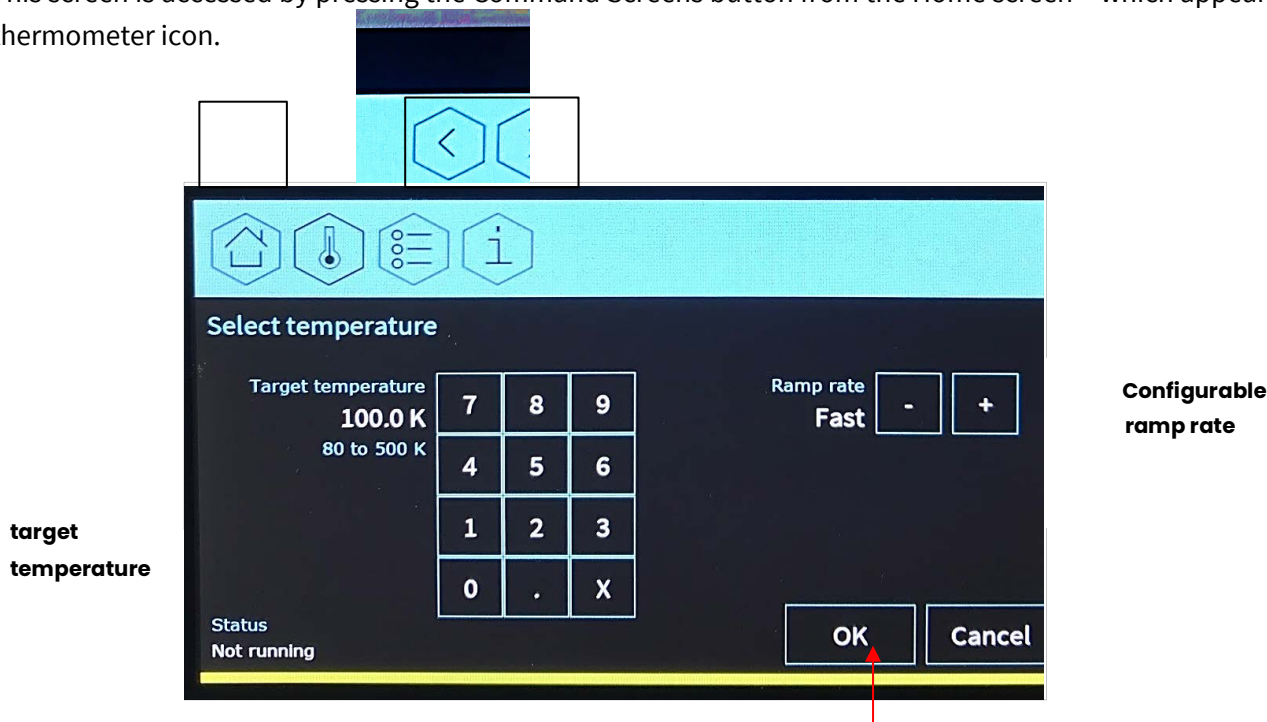

Figure 7.11 Key to command screen 1

Target Temperature: Use this keypad to enter the setpoint temperature at the crystal position.

Rate: This parameter determines the speed at which the gas temperature of the Cryostream is adjusted (from the current gas temperature to the desired setpoint). This can be specified in an exact figure K / min by using the + and – keys. Alternatively, by selecting the ‘Fast’ option the system will attempt to cool as quickly as possible.

Pressing ‘OK’ sets the parameters and confirms any changes. Pressing ‘Cancel’ will discard any pending changes and retain the original configuration.

NOTE

7.3.2 Setting the gas flow

This screen is accessed by pressing the settings button, and use the left and right arrows to scroll through the screens.



Gas Flow	N2 Gas Flow	<ul style="list-style-type: none"> • Normal • Turbo • User defined
	Shield Gas Flow	<ul style="list-style-type: none"> • Normal • Turbo • User defined

It is possible to set the nitrogen flow rate of the Cryostream using the options on the left, and the shield flow via the options on the right. The shield flow contains a 'Run' option which operates the dry air independently of the cooling gas.

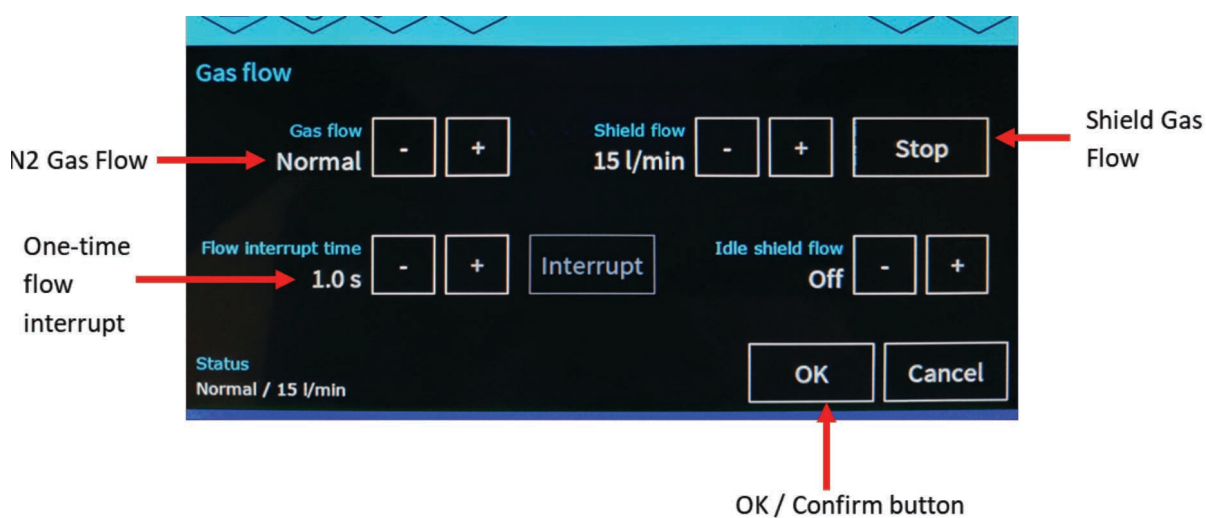

Figure 7.12 Command screen 2 showing gas flow settings

The two options are toggled using the '+' or '-' buttons. Pressing OK will implement the current selection and return to the Home screen. The two options are further explained in the table below.

Normal	<p>This is the default flow setting. The system will use 5 l/min gas flow except in a Cool or below 90 K. A Cool 10 l/min is used to maximise the cooling speed. Flow rates greater than 5.0 l/min are also used to achieve temperatures < 90 K</p>
Turbo	<p>The system will use 10 l/min gas flow except above 310 K. Above 310 K available heater power limits the maximum achievable flow to 5 l/min</p>
Interrupt	<p>This section allows the gas flow to be stopped for a specified duration (e.g. for a temporary warming of the sample, or to observe rapid phase changes during heating / cooling events) Use the + and - keys to adjust the interrupt time Once the 'Interrupt' button is pressed the flow will be paused for the specified duration. It will then</p>

7.3.3 Set shutdown options

The Cryostream can be programmed to shut down in a number of ways using Command screen 3; this screen is accessed by pressing the Command button from the Home screen, followed by the Next screen button. It is used to program a shutdown event.

Shutdown	Shutdown Mode	<ul style="list-style-type: none"> • Stop • Purge • Regen
-----------------	----------------------	--

Select shutdown type

OK / Confirm button

Figure 7.13 Command screen 3 showing shut-down options

Pressing OK will implement the current selection and activate the timer (if applicable) associated with each of the settings.

Stop	The gas flow is halted and the system is stopped at the current temperature.
Purge	The gas flow is halted and the whole system is brought up to 300 K using its internal heaters, at which point the system stops.
Regen	This option should only be used when performing a reactivation operation (please read Appendix 3 first). In this instance the supplied vacuum pump, reactivation heater and cable must also be connected to the GSM.

NOTE

Pressing the Stop button on the home screen whilst running will immediately stop the system.

7.4 INFORMATION SCREENS

The controller has a number of screens that can be cycled through for monitoring of the Cryostream. These are not necessary during normal operation, but you may be asked to view these by our technical support team to collect various information about the system. To access the Info Screens, press Info and use the left and right arrows to scroll through the screens. There are 6 info screens in total, we show only a single example below. However if the technical support team ask for various parameters to be read from the controller, they will clearly specify which screen(s) should be accessed.

MENU LEVEL 1	MENU LEVEL 2	SELECTION
Information screens	Device Information	For information only
	Live Diagnostics	
	Last Error Information	
	Flow Diagnostics	
	Relay Board Diagnostics	
	Debug Parameters	

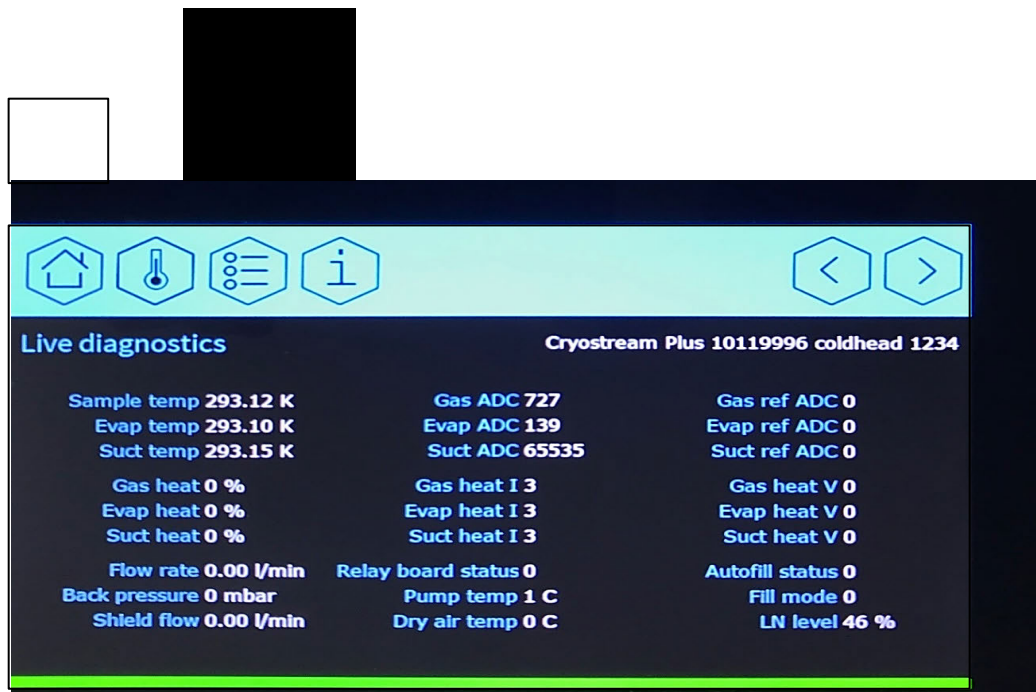

Figure 7.14 Info screen 1: Sensors and heaters

Displayed here are various properties of your system including serial numbers and hour count. Also shown are the current settings used for the Ethernet connection.

7.5 ERRORS AND WARNINGS ON THE GAS SUPPLY MODULE (GSM)

The Cryostream controller will change its appearance when it presents an error condition or warning.

Should an error condition occur which causes the system to shut down, the LEDs on the Cryostream head will flash red along with the colour status bar on the Home screen, as shown below.

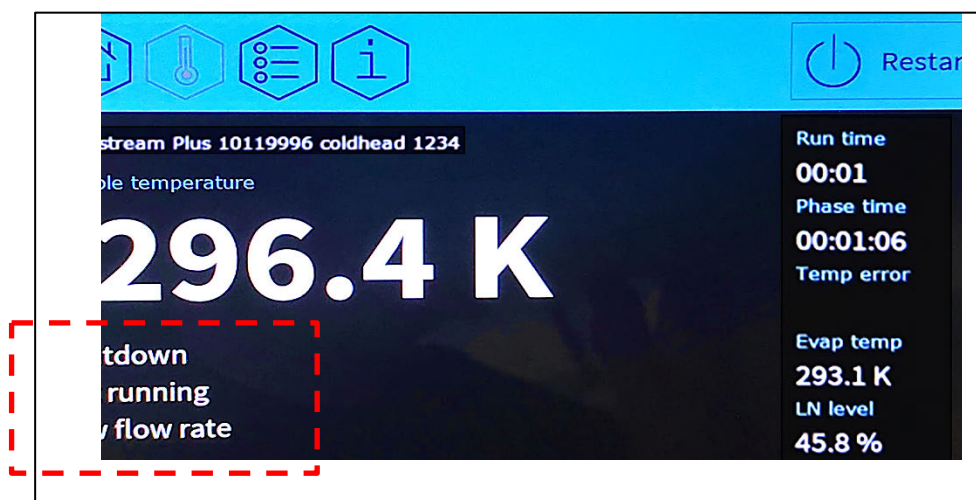

will also be flashing red).

Figure 7.15 Home screen after system has shut-down with error

If your unit displays an error or warning, please refer to Appendix 2 Cryostream Troubleshooting Guide or contact Oxford Cryosystems' Support Team by e-mailing support@oxcryo.com or calling +44 (0)1993 883 488. Once the issue has been resolved, the controller can be re-started by pressing the Start/Stop button.

8 MAINTENANCE



CAUTION

It is recommended that a FORCE be conducted either a) every 10 days if the Cryostream has been running constantly without switching off or, b) if there is an ice blockage in the Cryostream (Please see Page 57 for list of associated errors). The Stop command should be used for routine shutdowns.

8.1 SERVICE INTERVALS

The user interface has a specific page which contains an hour counter (shown below). This will present service notifications for the dry air supply and pumps. Once the service routines have been performed, these warnings can also be reset through this page.

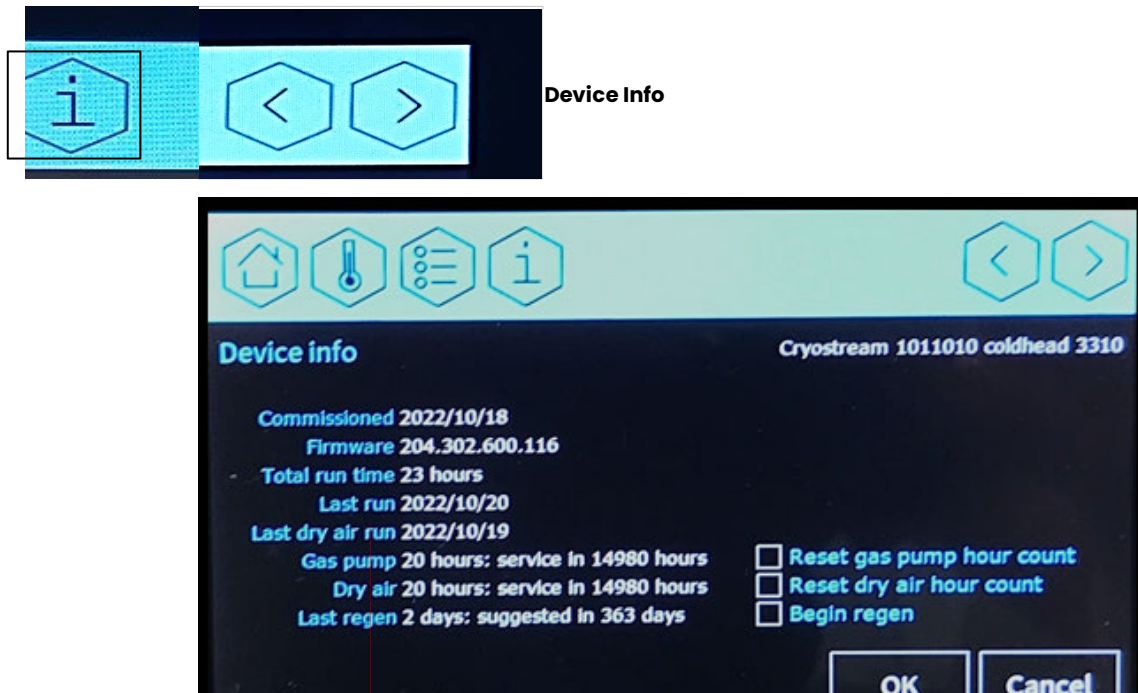

Figure 8.1 Device info screen showing the hour counter

Procedure	Typical Service Interval	Comments
Pump down of Vacuum / Reactivation Interval	6-18 months	<p>The touch screen indicates how many hours the system run and when it is necessary to re-pump the vacuum space as this will deteriorate over time. Please note that the vacuum space in 3m transfer lines will deteriorate faster than the standard 1.5m lines (due to volume differences) so these Cryostreams may need more regular pumping.</p> <p>Details about the vacuum pump down and reactivation procedure are found in 0.</p> <p>For signs of vacuum deterioration, see Cryostream Troubleshooting Guide.</p>
Replacement of Line Drier	6-12 months	<p>Replacement of the line drier units are recommended as they will eventually become saturated with water vapour from the nitrogen supply.</p>
Service of Dry Air Compressor (Using GSM Service Kit)	12,000 Hours	<p>The touch screen indicates how many hours the dry air compressor has been operational and when the service is required.</p> <p>The required parts are included in the GSM Service Kit. All Cryostreams come with a GSM Service Kit included, and more can be purchased from Oxford Cryosystems or your local agent.</p>
Dewar Cleaning	2-3 months	
Replacing diaphragms in the gas pump (Using GSM Service Kit)	10000-12000 hours	<p>The touch screen indicates how many hours the dry air compressor has been operational and when the service is required. Split or worn diaphragms will cause premature ice blockages in the system. A</p> <p>Replacement Diaphragms are included in the GSM Service Kit. All Cryostreams come with a GSM Service Kit included, and more can be purchased from Oxford Cryosystems or your local agent.</p>

For further advice or information on maintenance procedures, please contact support@oxcryo.com

While all of our devices are designed to be as efficient and economical to maintain as possible, as with any mechanical system, some level of maintenance will be required. As always, Oxford Cryosystems continues to offer free unlimited technical support to allow you to carry out minor service work; however, in response to demand from our customers, we are pleased to now offer a choice of pre-paid maintenance contracts. Please contact support@oxcryo.com for more information on the service contracts available.

APPENDIX 1 REMOTE CONTROL AND MONITORING OF THE CRYOSTREAM

The 1000 Series Cryostream may be controlled and monitored from a PC using our CryoConnector software. CryoConnector is available free of charge from connect.oxcryo.com and is also found on the USB drive provided with your Cryostream.

Oxford Connect is a free online platform that can be used with the CryoConnector software to control and monitor a Cryostream from any web-enabled device such as a tablet, smartphone or remote PC. By registering your new device at Oxford Connect, you will be able to:

- Connect to your Cryostream via the web.
- Remotely monitor and control your Cryostream from a PC, smartphone or tablet.
- Automatically log your device data.
- Enable Oxford Cryosystems to remotely view your device performance for faster tech support.
- Receive status notifications when your device status changes.

NOTE

The Cryostream can only be monitored and controlled by one piece of PC software at a time through each port; e.g. if you are using the USB port to connect to the controller through CryoConnector, you will need to use the serial or Ethernet ports to connect to the Cryostream using software made by your diffractometer manufacturer.

Installing CryoConnector

NOTE

Oxford Cryosystems' CryoConnector software requires Windows 10 or later.

CryoConnector can be downloaded from the Oxford Connect website (connect.oxcryo.com) or installed from the USB drive provided with your Cryostream.

Oxford Connect Website:

1. Create an account with the Oxford Connect website using the Device ID for your Cryostream (found on a card on top of the Cryostream controller).
2. Once registered, press the "Download CryoConnector" button on the homepage.
3. Open the downloaded file from your downloads folder (Ctrl+J) open your download folder this in most browsers).
4. An installation wizard will walk you through installing CryoConnector.

USB Drive:

Your Cryostream system will come with a USB drive containing an electronic copy of our manuals and software.

1. Insert this into your PC and run the open the USB drive to access these files.
2. Select the CryoConnector file to initiate an installation wizard that will install CryoConnector.

NOTE

When connecting the Cryostream 1000 to your PC via USB, depending on your PC settings, the USB driver may or may not automatically download. If the controller drivers do not download, it can be installed from the USB storage drive provided with your system.

Logging in to Oxford Connect using CryoConnector

NOTE

The PC connected to the Cryostream (which is running CryoConnector) will need a permanent internet connection to successfully use Oxford Connect.

Press F6 when CryoConnector is running to open the Oxford Connect window (Figure). From this window, you can log in to Oxford Connect to link your Cryostream to your Oxford Connect account:

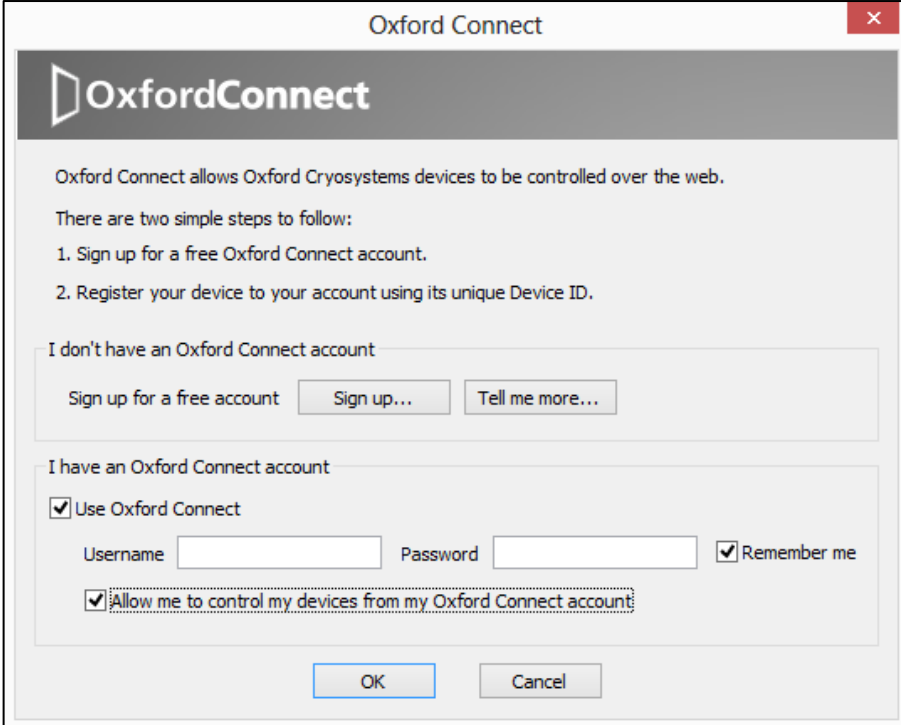

The screenshot shows a window titled "Oxford Connect" with a close button in the top right corner. The window contains the OxfordConnect logo and the following text: "Oxford Connect allows Oxford Cryosystems devices to be controlled over the web. There are two simple steps to follow: 1. Sign up for a free Oxford Connect account. 2. Register your device to your account using its unique Device ID." Below this, there are two sections: "I don't have an Oxford Connect account" with buttons for "Sign up for a free account", "Sign up...", and "Tell me more..."; and "I have an Oxford Connect account" with a checked checkbox for "Use Oxford Connect", input fields for "Username" and "Password", a checked checkbox for "Remember me", and a checked checkbox for "Allow me to control my devices from my Oxford Connect account". At the bottom are "OK" and "Cancel" buttons.

Figure A1: CryoConnector Oxford Connect Window

1. If you don't have an account, press the "Sign up..." button to go to the Oxford Connect website and create an account.
2. If you have an account, select "Use Oxford Connect" tick box to allow connection to Oxford Connect.
3. Fill in your Username and Password that you chose when setting up your account.
4. Selecting the "Allow me to control my devices from my Oxford Connect account" tick box will allow you to send commands from online devices to your Cryostream
5. Selecting the "Remember Me" will allow CryoConnector to remember your log-in details.

Monitoring and Controlling the Cryostream through CryoConnector

CryoConnector consists of three sections accessible in a single window: Overview, Commands and Display. The Overview section is always visible, while the Commands and Display sections can be hidden or revealed by pressing the "Commands" and "Display" buttons.

If multiple Oxford Cryosystems devices are connected to the same PC, they will all appear in the same CryoConnector window.

CryoConnector will be continuously updated by our software engineers and so the appearance may change and new features may be added as new versions are released. For information on any new features or to suggest new features that would be useful, contact Oxford Cryosystems (support@oxcryo.com).

CryoConnector Overview Section

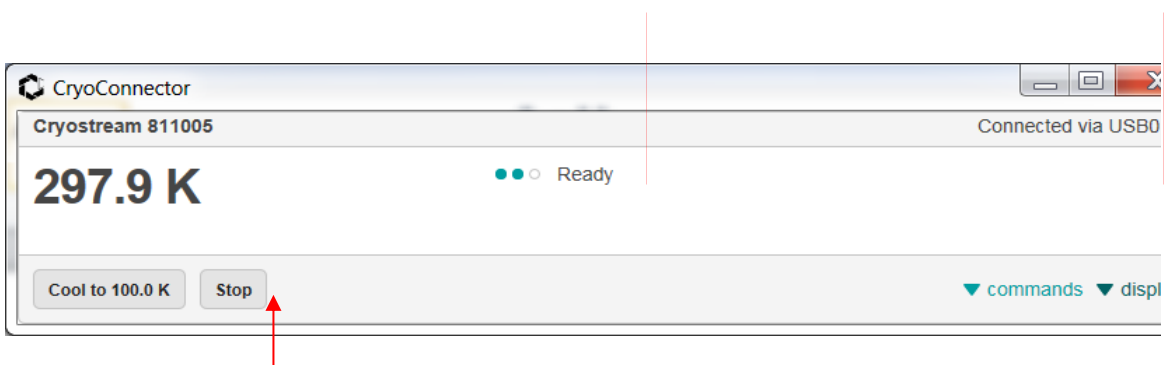

Figure A2: CryoConnector showing Overview Section only

297.9 K

- 1) **Current Gas Temperature:** Shows the current nitrogen gas temperature at the crystal position.

Cryostream 811005

- 2) **Device Serial Number:** Displays the model and serial number of the device.

●●○ Ready

- 3) **Current Status:** When running, shows total run time of current Cryostream run, the current target (setpoint) temperature and rate of change and any errors or warnings; otherwise shows the current status of the Cryostream.

Connected via USB0

- 4) **Connection Status:** Shows which port of your PC the Cryostream is connected to CryoConnector through. Moving blue chevrons confirm an active connection to Oxford Connect; a red cross shows that there is no connection with Oxford Connect.

Cool to 100.0 K

Stop

- 5) **Cool to favourite button:** Commands the Cryostream to change temperature to the temperature displayed as quickly as possible, overwriting the existing command.

- 6) **Stop button:** Commands the Cryostream to stop running immediately.

▼ commands ▼ display

- 7) **Commands and Display buttons:** Show (and hide) more CryoConnector functions.

CryoConnector Commands Section

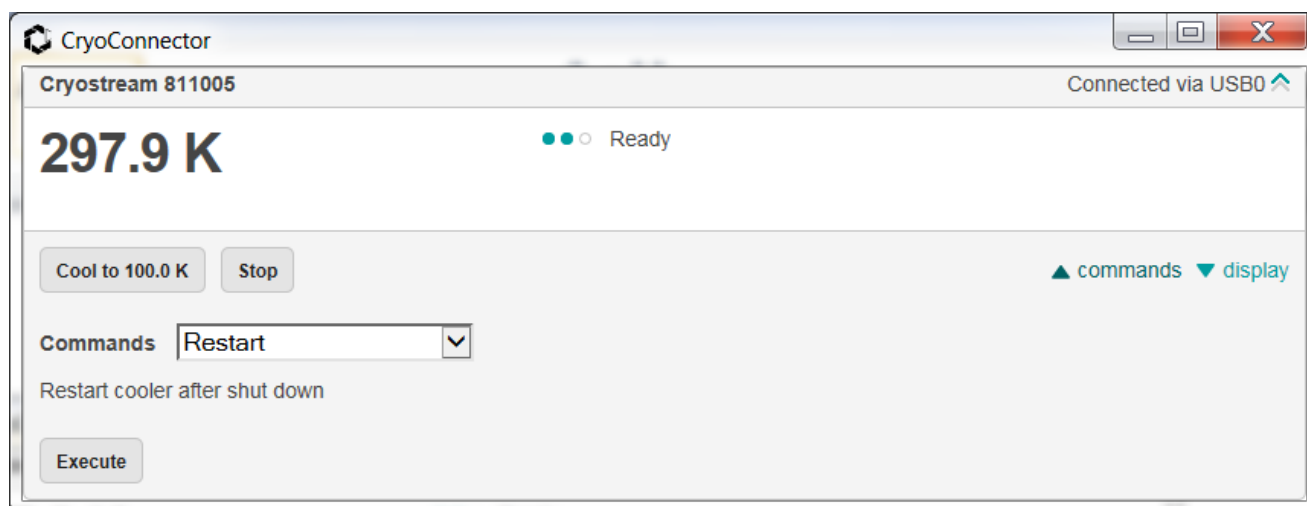

Figure A3: CryoConnector showing Commands Section

The Commands section can be used to give commands to the Cryostream.

The options in the Commands drop-down list are:

Command Name	Meaning
RESTART	Stop Cryostream and re-initialize system back to “Ready”.
RAMP	Change gas temperature to a set value at a controlled rate.
COOL	Make gas temperature decrease to a set value as quickly as possible.
PLAT	Maintain the current temperature for a set amount of time.
HOLD	Stay at the current temperature indefinitely with no ability to resume the previous command (unlike the SUSPEND and RESUME functions).
END	Bring the gas temperature to 300 K, then shut down.
PURGE	Bring the gas temperature and the internal temperature to 300 K then shut down.

Pressing the “Execute” button will cause the 1000 Series Cryostream to carry out the phase currently shown.

CryoConnector Display Section

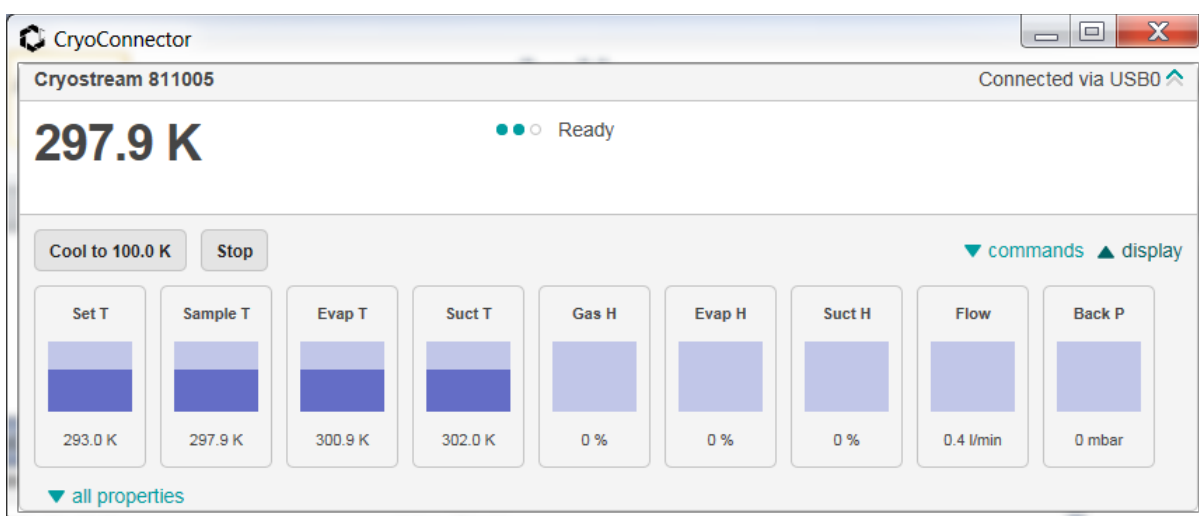

Figure A4: CryoConnector showing Display Section

Pressing the “Display” option will display a range of 1000 Series Cryostream parameters (as per 7.4 – Information Screens). Further parameters can be viewed by pressing the “all properties” button; these may be useful to report when liaising with Oxford Cryosystems support.

Using Oxford Connect

Your Oxford Connect account can be accessed by visiting connect.oxcryo.com using your web browser. Oxford Connect is compatible with a wide range of internet browsers.

- Once you have logged in, click on “My Devices” to view the Oxford Cryosystems devices registered to your account as well as information on those that are currently connect to Oxford Connect through CryoConnector. Any devices connected to Oxford connect through CryoConnector can be controlled

through Oxford Connect. The interface on Oxford Connect is the same as the CryoConnector interface described above, but is viewed in your browser window.

If you have any issues with CryoConnector or Oxford Connect, please contact Oxford Cryosystems (support@oxcryo.com) for further information.

Other CryoConnector Functions

CryoConnector has a range of other options that can be accessed by pressing a function button or by accessing the Menu.

NOTE

Access the Menu by single-clicking on the hexagonal Oxford Cryosystems logo in the top left of the window.

Option Name	Shortcut	Use
Help	F1	Access online help about using CryoConnector and Oxford Connect.
Connections	F3	View devices currently connected to CryoConnector.
Settings...	F4	Set the data log storage location for each device.
Scan for Devices	F5	Check all available computer ports for Oxford Cryosystems devices.
Oxford Connect Settings	F6	Log in and change settings for connection with Oxford Connect.
Visit Oxford Connect	F7	Open the Oxford Connect webpage in your browser.
Set Device Alias		Name or rename your Cryostream so it is easier to identify on CryoConnector and Oxford Connect.
Check for Updates		Check the Oxford Cryosystems server for updates to the CryoConnector software.
About...		Show current version of CryoConnector software.

NOTE

CryoConnector is frequently updated by the Oxford Cryosystems' Software development team to include new features. CryoConnector can be set to automatically check for updates on start-up; the option for this is found in the "About CryoConnector..." option on the menu.

APPENDIX 2 CRYOSTREAM TROUBLESHOOTING GUIDE

NOTE

Oxford Cryosystems offers free-of-charge technical support for all of its products; please do not hesitate to contact us with any problems.

support@oxcryo.com

+44 (0) 1993 88 34 88

The following information is intended for use by operators of the Cryostream. It is intended to provide the correct solution to a range of common technical problems, but it does not cover every technical possibility for the Cryostream.

Do not rush into changing components in an attempt to fix the Cryostream as changes may mask existing symptoms and increase the length of time taken to resolve a problem.

Some major issues will be detected by the Cryostream controller and will produce an error and will cause the Cryostream to stop; the controller screen text will turn red, the controller status bar will also turn red and the error will be displayed on the home screen. Please see the table on the next page if you have an error.

Some minor issues will be detected by the Cryostream controller and will produce a warning; these will be displayed on the home screen, but will not cause the Cryostream to stop. Please see the table on the next page if you have a warning.

Some issues are not detected by the Cryostream controller and so do not give an error or warning status; please see the “Symptoms” table on the next page if you have an issue but no error or warning.

Further information on some of these issues is given on the subsequent pages.

Error	Description	Action
Temp Control Error	Difference between requested temperature and actual temperature is greater than 25 K.	Flow Chart 1 – Suspected Vacuum Issue.
Flow Rate Fail	Nitrogen gas flow has dropped too low.	Flow Chart 2 – Suspected Ice Blockage.
Self-Check Fail	Cryostream controller has detected a problem.	Check Cryostream is set up correctly. Follow Process 1
SUCT Temp Error	SUCT connector temperature is too high or too low.	Check Cryostream is set up correctly. Follow Process 1
Temp Reading Error	Cryostream controller has detected nonsense sensor reading.	Check Cryostream is set up correctly. Follow Process 1
Sensor Fail	Cryostream controller has detected a faulty sensor.	Check Cryostream is set up correctly. Follow Process 1.

Warning	Description	Action
Temp Warning	Difference between requested temperature and actual temperature is greater than 10 K.	See Flow Chart 1 – Suspected Vacuum Issue.
High back pressure	Cryostream controller has detected a blockage in the nitrogen flow path.	See Flow Chart 2 – Suspected Ice Blockage.

Symptom	Action
Inability to reach low temperatures	See Flow Chart 1 – Suspected Vacuum Issue.
Reaches low temperature, then temperature starts to increase	See Flow Chart 1 – Suspected Vacuum Issue.
Poor temperature stability	See Flow Chart 1 – Suspected Vacuum Issue.
Condensation on the Cryostream coldhead and/or transfer line	See Flow Chart 1 – Suspected Vacuum Issue.
Cryostream carries out a PURGE phase then shuts down	See Flow Chart 2 – Suspected Ice Blockage.
Icing on the Cryostream coldhead nozzle tip	See Flow Chart 3 – Icing on Nozzle Tip
Icing on the sample position	See “Icing on the Sample Position” below.
Liquid nitrogen coming out of the Cryostream coldhead nozzle	Contact Oxford Cryosystems for support.
Controller turns off unexpectedly	See Flow Chart 4 – Power Failure.
Controller will not turn on	See Flow Chart 4 – Power Failure.

Process 1: Navigation to the diagnostic screens

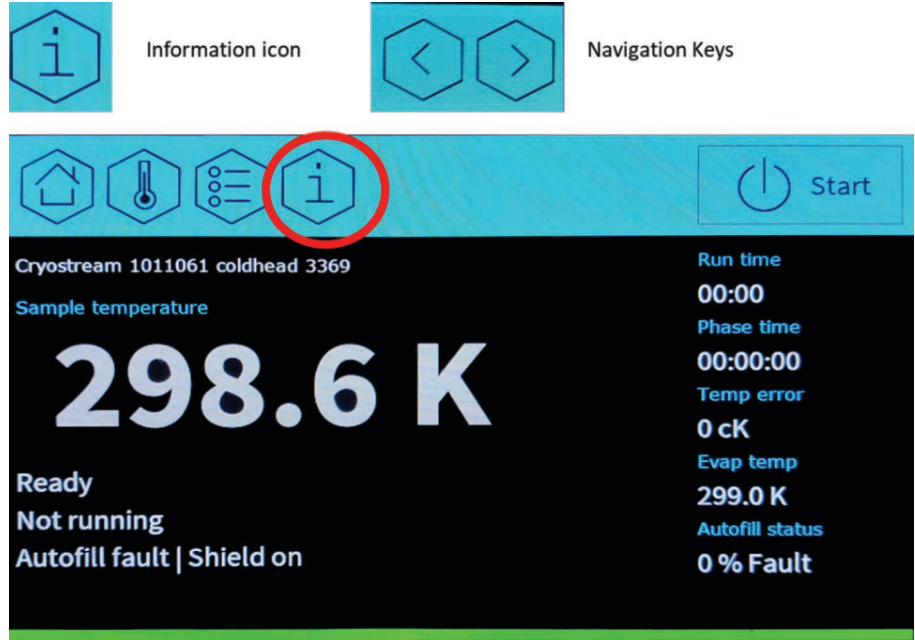

From the home page, navigate to the relevant screens using the information icon (displayed above) and then navigate to the relay board diagnostic screen, the live diagnostic screen and the flow diagnostic screen. Take photos of these and attach them to an email to support@oxycryo.com along with the serial number of the GSM and Coldhead. See below the relevant images to send:

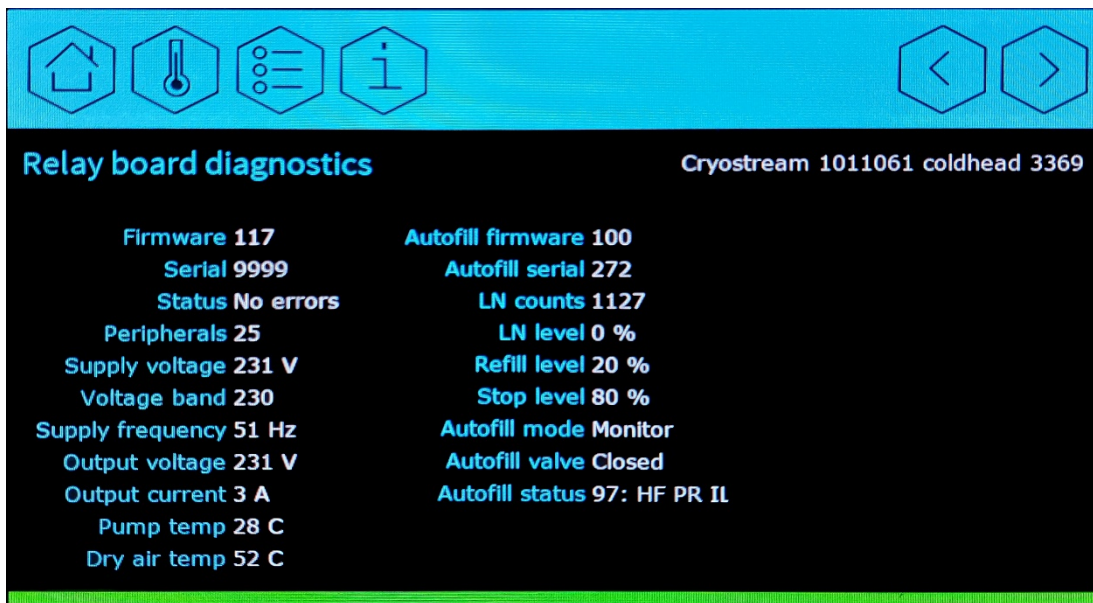



Live diagnostics

Cryostream 1011061 coldhead 3369

Time stamp 11:10 2023/05/16

Sample temp 298.57 K	Gas ADC 7980	Gas ref ADC 23963
Evap temp 299.01 K	Evap ADC 8007	Evap ref ADC 24007
Suct temp 297.76 K	Suct ADC 8033	Suct ref ADC 23950
Gas heat 0 %	Gas heat I 67	Gas heat V 0
Evap heat 0 %	Evap heat I 5	Evap heat V 0
Suct heat 0 %	Suct heat I 4	Suct heat V 0
Flow rate 0.03 l/min	Relay board status No errors	Autofill status 97: HF PR IL
Back pressure 1 mbar	Pump temp 27 C	Autofill mode Monitor
Shield flow 11.95 l/min	Dry air temp 53 C	LN level 0 %



Flow diagnostics

Cryostream 1011061 coldhead 3369

Firmware 600	Interrupt time 1 s	Flow zero 2051
Serial 2	Interrupt state 0	Flow PDE 11558
Flow set point 0.00 l/min	Interrupt count 0	Shield zero 2053
Flow rate 0.05 l/min	Device type Double flow	Shield PDE 6538
Back pressure 0 mbar	Calibration Complete	Back p zero 419
Flow valve 0 %	Flow counts 2052	
Shield set point 12.00 l/min	Back p counts 421	
Shield flow 11.97 l/min	Shield counts 2876	
Shield valve 68 %		

Flow Chart 1

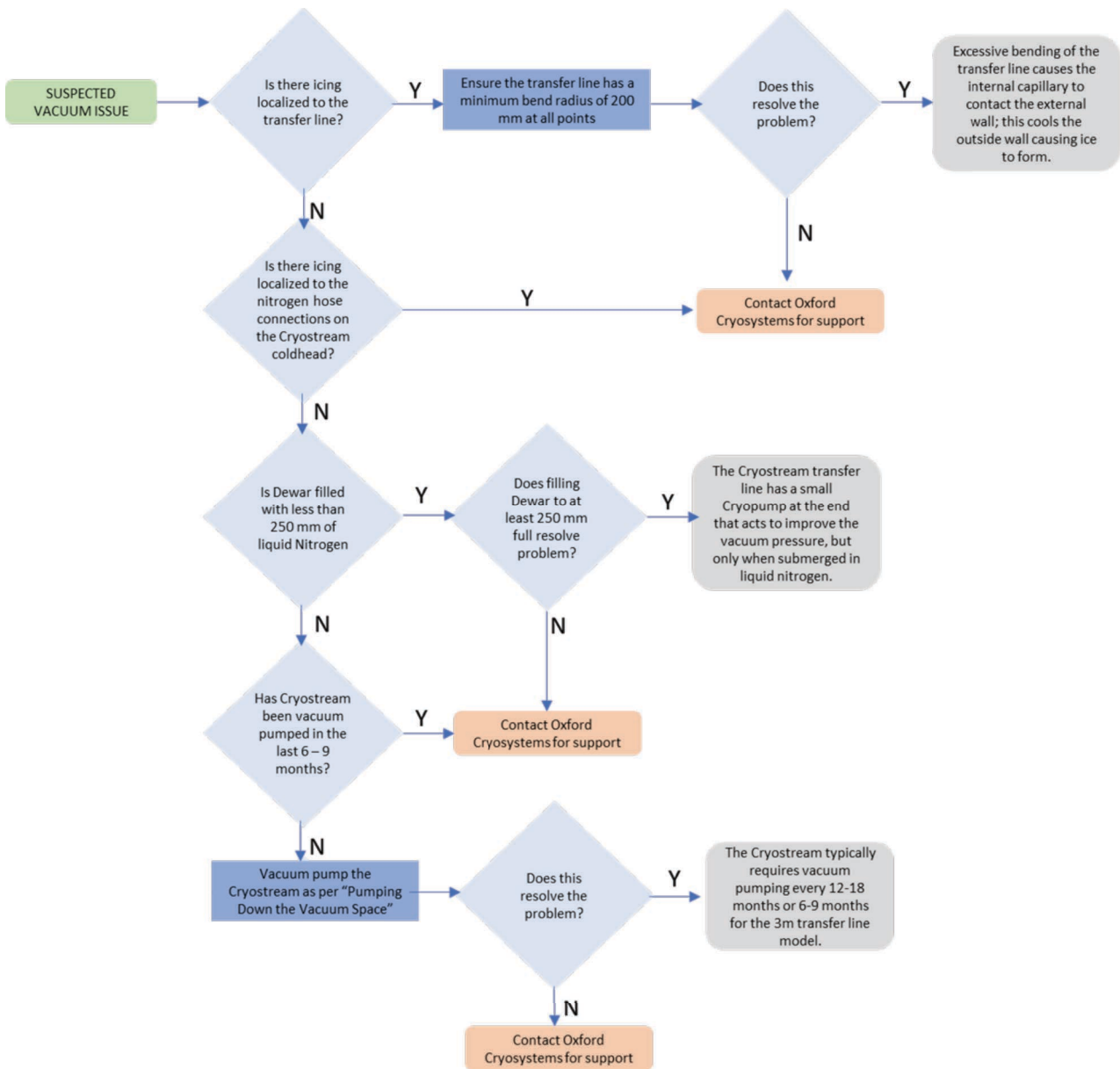

Flow Chart 2

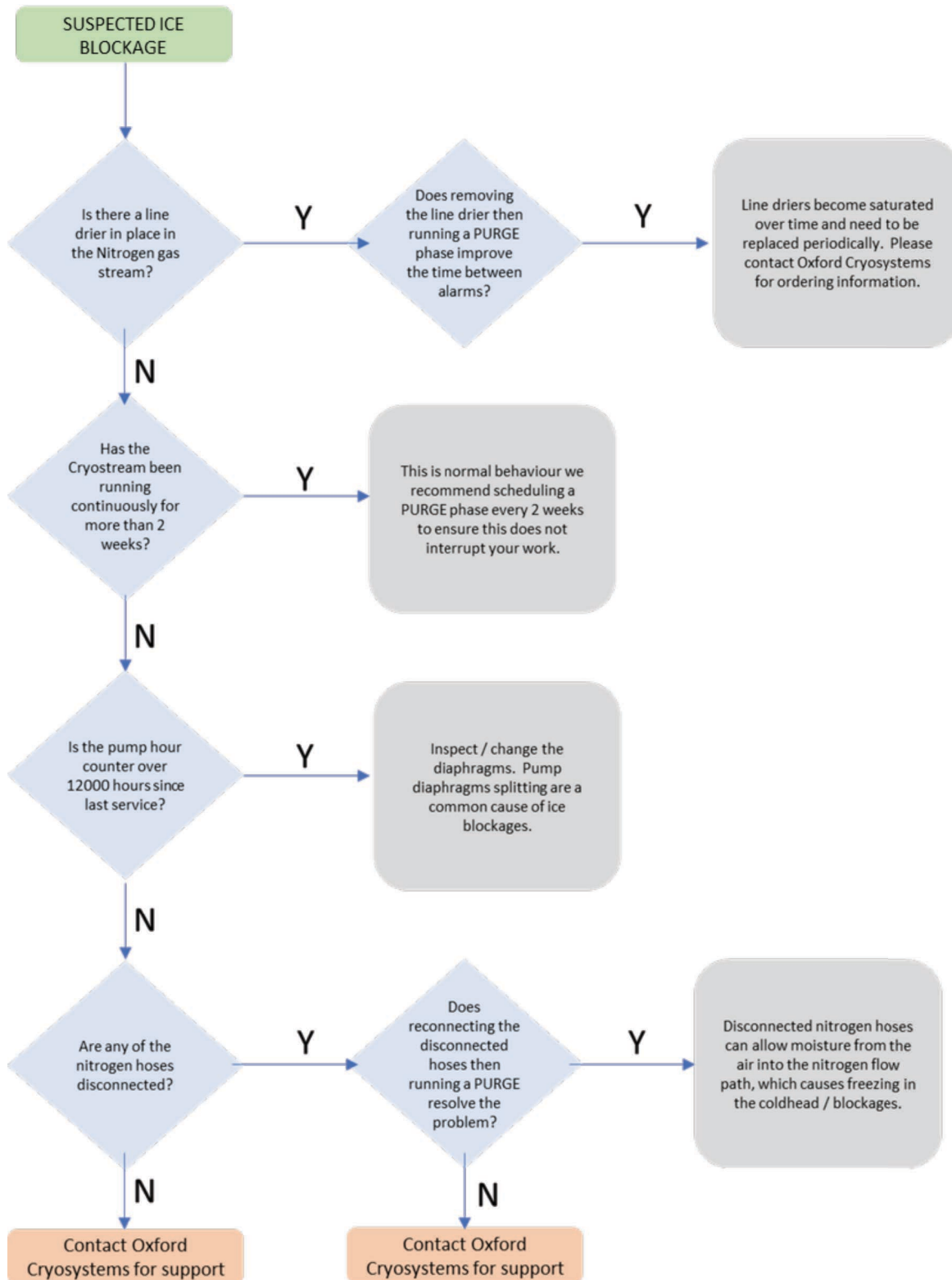

Flow Chart 3

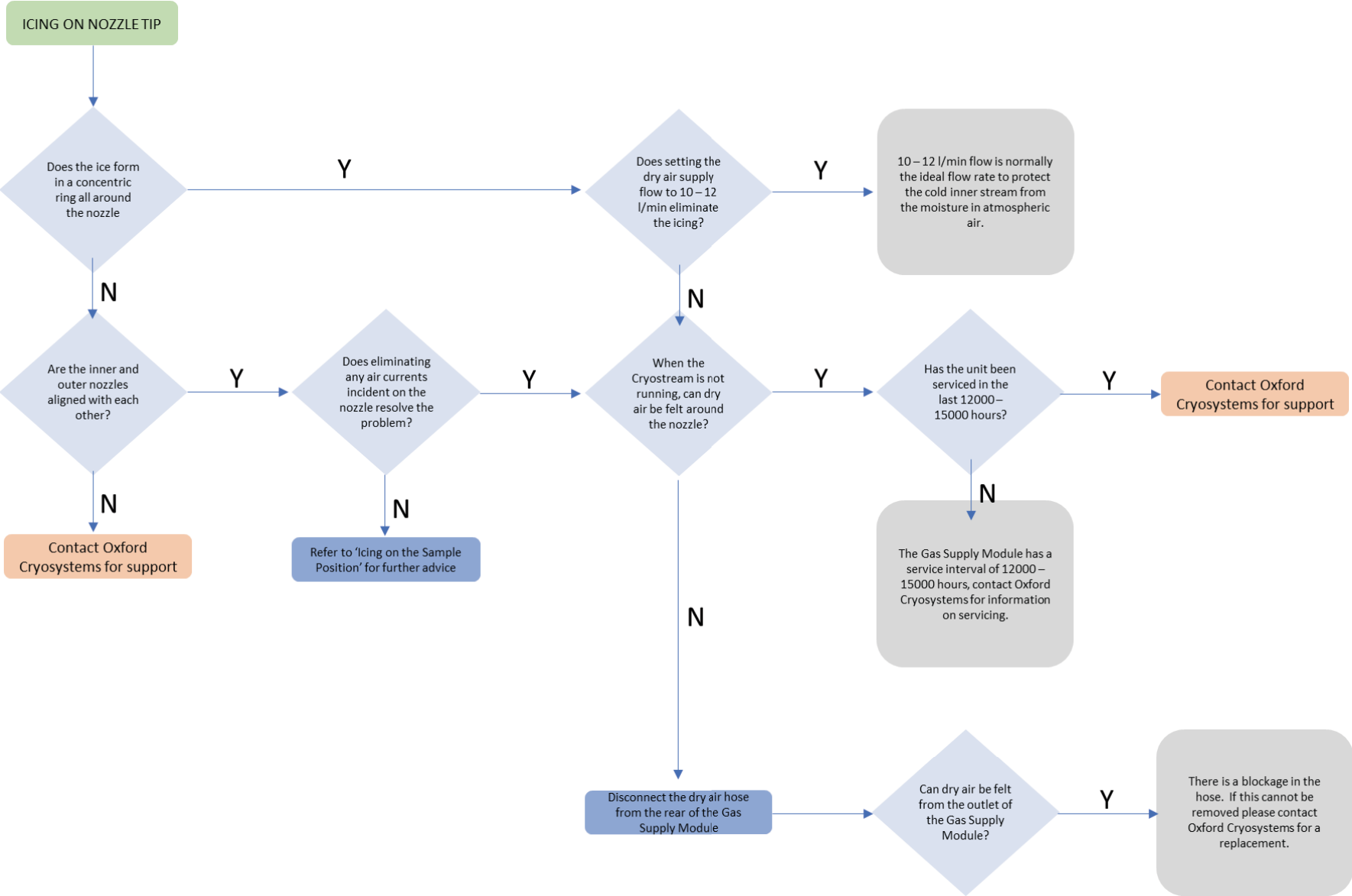

Flow Chart 4

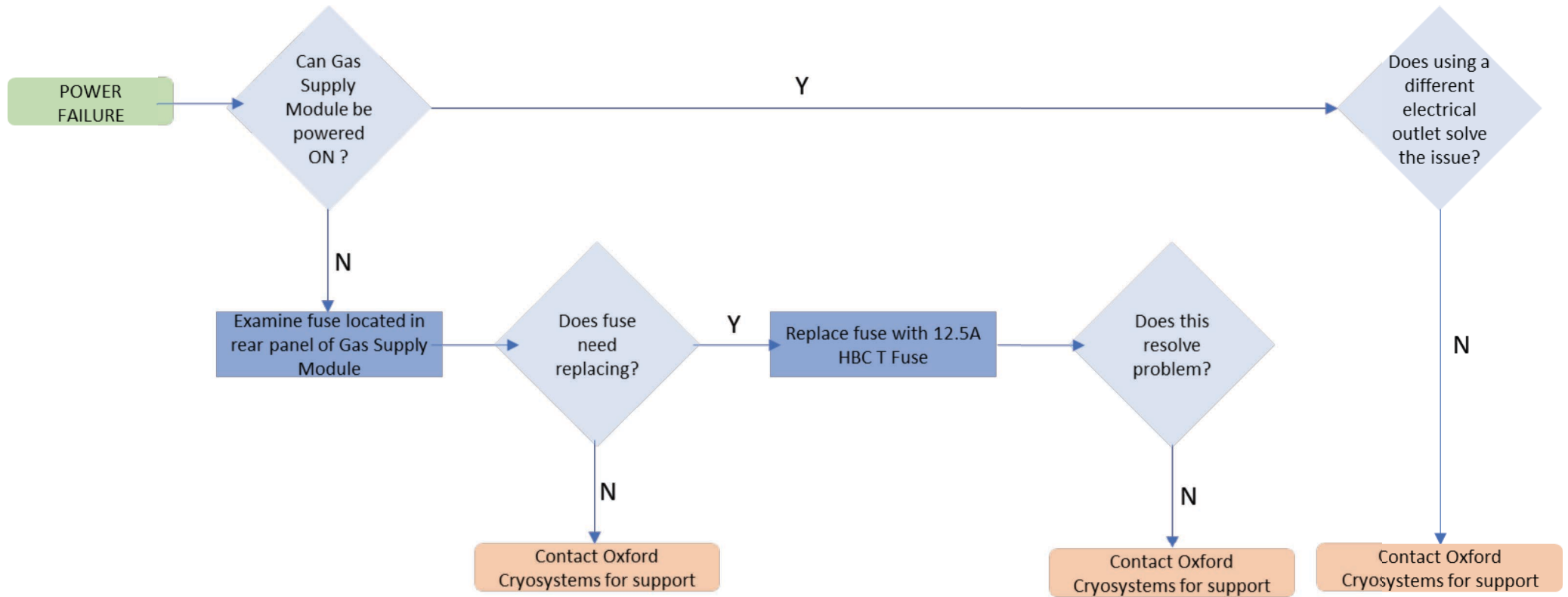

Icing on the Sample Position

Icing on the sample position is usually caused by environmental factors or the sample mount itself. Please find below a list of possible causes of icing on the sample or sample mount and suggestions on how this can be avoided.

Cause of Icing	Possible Solutions
1. The sample is too far away from the nozzle or not aligned in the centre of the cold stream. The cold stream and the dry air stream mix and draw in atmospheric moisture that is frozen out on the sample.	Position the nozzle as close to the sample as possible without affecting the path of the x-rays or casting an image on to the detector. The ideal position is inside the first 6 mm from the end of the nozzle and the centre 2 mm of the flow. A nozzle alignment tool is available from Oxford Cryosystems to aid this.
2. A disturbance of the laminar flow system due to drafts in your laboratory.	Check the laboratory for drafts; the most likely cause of turbulence is an air conditioning unit, a cooling fan from an x-ray generator or the rotating anode generator. Create a screen between the source of the draft and your cold stream.
3. An interruption of the laminar flow caused by an oversized sample mount (i.e. capillary or pin is too thick).	If possible, try using a smaller or thinner sample mount.
4. The inner (cold) and outer (room temperature) gas streams are not creating a laminar flow.	Try adjusting the flow of the outer dry gas stream. In a draft-free environment 10 L/min is fine, but when the air is more turbulent, try turning the outer stream flow rate up to 12 to 15 L/min; this can often resolve the problem. Also, see “Flashlight Test” below.
5. The loop is unclean. Any particles on the loop will propagate ice formation.	Ensure that the loop is clean and free of particles before use.
6. The angle between the Cryostream nozzle and the pin is less than 90°. This can cause the pin to interfere with the gas stream prior to it reaching the crystal, disrupting the laminar flow and so cause icing.	Increase the angle between the Cryostream and the pin. Cryostreams can be mounted from below in some situations; please contact Oxford Cryosystems for details.
7. Insufficient cryoprotection of the buffer solution. Too much mother liquor results in dilution of the cryoprotectant to the point where it is no longer adequate. A thick film around the crystal may result in a larger thermal mass that must then be cooled.	To increase the effectiveness of the cryoprotectant, increase its concentration.

Flashlight Test

To be sure the flow rate of the outer dry air stream is correct, it is often better to set the flow by eye rather than by trying to guess what the flow should be by looking at the numbers. Turn all the lights off in the laboratory and shine a flashlight up towards the nozzle of the coldhead in an attempt to highlight the plume created by the cold gas stream. As the gas stream leaves the nozzle it is really made up of two parts; the first 'invisible' 10 or 12 mm and the remaining plume of ice. The object of the exercise is to maximise the length of the 'invisible' section. This should only be done over the first 15 L/min of air from the dry air source. One should not be fooled into thinking that at 25 L/min there is no plume, and therefore, no ice because the ice will build rapidly around the end of the nozzle and blow the sample from its support.

NOTE

Oxford Cryosystems offers free-of-charge technical support for all of its products; please do not hesitate to contact us with any problems.

support@oxcryo.com

+44 (0) 1993 88 34 88

APPENDIX 3 PUMPING DOWN THE VACUUM SPACE IN THE CRYOSTREAM

The vacuum space in the Cryostream will need to be evacuated (or pumped) occasionally to ensure it acts as an effective thermal insulator. Deterioration of vacuum may be noticed as excessively cold, wet or icy Cryostream coldhead and/or transfer line. You may also notice that the Cryostream is unable to hold a low set temperature and the gas temperature drifts slowly upwards. If you have any doubts as to whether a poor vacuum is the cause of these issues, please contact Oxford Cryosystems' support team: support@oxcryo.com, +44 (0) 1993 88 34 88.

NOTE

If you have any questions or concerns, please contact Oxford Cryosystems' support team: support@oxcryo.com, +44 (0) 1993 88 34 88



WARNING

The re-activation heater and the supplied power cable should only be connected to the "Reactivation Heater" port on the rear of Gas Supply Module.
Do not attempt to connect this to any other OCS equipment or power sources.

Tools Required

Tool	Time taken to complete	
Re-activation Heater	Supplied with Cryostream	
Vacuum pump (capable of 1×10^{-2} mBar ultimate pressure, 2.5 m ³ /hr pumping speed, e.g. Pfeiffer DUO 2.5)		
Vacuum hose		Not supplied with Cryostream.
Vacuum hose clamps, centring ring and O-rings (capable of connecting to NW16/KF16 flange on pump-out adaptor)		
Vacuum gauge		

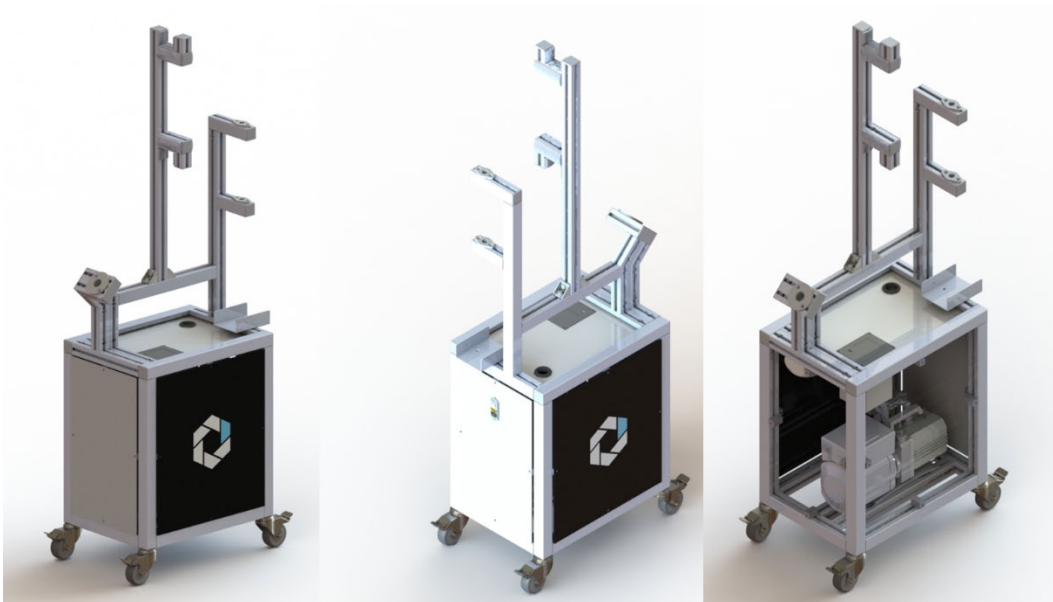

Figure A5 render of the assembled Vacuum Pump Station

Instructions

1. Switch off the Cryostream and leave it standing for 24 hours to warm internally or run a PURGE.
2. Remove the rigid section of the transfer line from the liquid nitrogen Dewar.
3. Leave the transfer line out of the liquid nitrogen Dewar for one hour to allow it to warm up, then dry it carefully.
4. Place the end of the rigid section of the transfer line into the hole of the re-activation heater.

NOTE

Do not turn the heater on at this stage.

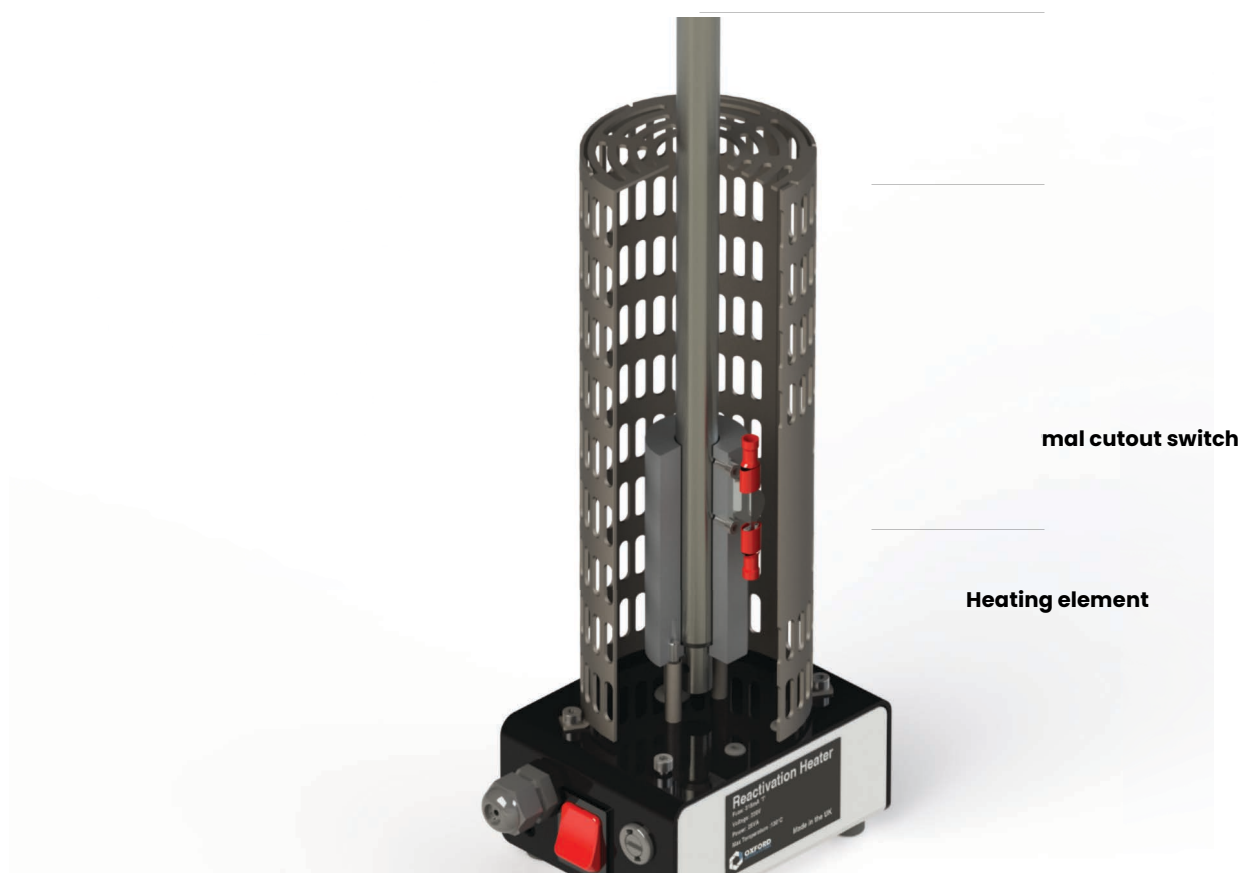

Figure A6 Transfer line in Re-activation heater

5. Connect your vacuum pump and gauge to the flange (NW16/KF16) on the pump-out adaptor.
6. Start the vacuum pump and ensure it is possible to obtain a vacuum pressure of at least 0.1 mBar with the sealing plug still in place to ensure there are no leaks in the vacuum equipment.

NOTE

7. Use the tool supplied to slowly pull the sealing plug out of the pump-out port on the transfer leg, exposing the Cryostream vacuum space to the vacuum pump. This is illustrated in the image below. The vacuum pump hose has been removed for clarity but should be connected to the flange shown. Do not open the port until the vacuum pump has been connected and is running.



Figure A7 Pump out port

8. Ensure the sealing plug is locked in the 'open' position, or the differential pressure of the vacuum will cause it close prematurely.
9. Wait until the pressure read by the vacuum pump/gauge assembly is 0.1 mBar or lower.
10. Turn on the re-activation heater via the control panel of the GSM, and by toggling the red switch on the front of the re-activation heater.

WARNING

The re-activation heater heats itself and part of the transfer line to 150-200°C. Ensure nothing will come into contact with the heater and do not touch the heater during or for some time after operation.

11. Pump the vacuum for at least 16 hours; ideally, the Cryostream should be vacuum pumped for up to 48 hours.

CAUTION

12. Ensure the vacuum gauge reads 0.01 mBar (1×10^{-2} mBar) or better.
13. Remove the locking pin and push the sealing plug on the transfer line back into the closed position.
14. Switch the re-activation heater off immediately, first via the on-screen commands, and secondly switch off the red toggle switch on the front of the re-activation heater.
15. Turn off the vacuum pump.
16. When it is safe to do so (according to the instructions in your vacuum pump), release the vacuum from the vacuum hose.
17. Disconnect the vacuum hose from the pump-out adaptor.
18. Once the end of the Cryostream transfer line has cooled, remove it from the CRH25 re-activation heater; it is now safe to re-install into the liquid nitrogen Dewar.

APPENDIX 4 REPAIRS AND RETURNS PROCEDURE

To allow Oxford Cryosystems to offer fast and accurate technical support, please quote the Cryostream Serial Number with all technical issues. It is worth keeping a record of this number in a convenient place:

CRYOSTREAM SERIAL NUMBER

This Cryostream serial number is _____

The four digit serial number can be found etched onto the top flange of the Cryostream Coldhead. The Gas Supply Module also contains details of the serial number along with details of regulatory approvals and warning hazards.



Figure A8 Location of serial number for the Cryostream

Returns procedure

Do not return any equipment without contacting Oxford Cryosystems in advance. Use the following procedure to return ANY items for repair.

1. Contact Oxford Cryosystems (support@oxcryo.com) and obtain a Return Material Authorisation (RMA) number for the equipment which must then be written on each box being returned. Without this number Oxford Cryosystems may reject the consignment. Oxford Cryosystems will email a form which must be filled out and emailed or faxed back prior to sending the consignment.
2. Remove all traces of dangerous substances and any accessories that will be returned to Oxford Cryosystems. Drain all fluids and lubricants from the equipment and its accessories.
3. Disconnect all accessories from the equipment. Safely dispose of the filter elements removed from inside any oil mist filters.
4. Seal up all of the equipment's inlets and outlets (including those where accessories were attached). It is recommended that they are sealed with blanking flanges or heavy gauge PVC tape.
5. Seal contaminated equipment in a thick polythene bag or polythene sheet.
6. If possible, pack your equipment into its original packaging for return to Oxford Cryosystems.
7. If the equipment is large, strap the equipment and its accessories to a wooden pallet. Preferably, the pallet should be no larger than 510 mm x 915 mm (20"x 35").
8. If the equipment is too small to be strapped to a pallet, pack it in a suitable strong carton.
9. If the equipment is contaminated, label the pallet (or carton) in accordance with laws covering the transport of dangerous substances.

APPENDIX 5 LIQUID AND GASEOUS NITROGEN SAFETY SHEET

General

These safety points are a guideline to outline the potential hazards and procedures involved in the handling of liquid or gaseous nitrogen. Anyone handling liquid or gaseous nitrogen should first inform their departmental or laboratory safety advisor and receive advice about local safety procedures.

All users are requested to read this safety sheet before handling the Cryostream. Oxford Cryosystems accept no responsibility for injury or damage caused by the mishandling of liquid or gaseous nitrogen.

General properties

- Gaseous nitrogen is colourless, odourless and tasteless and is slightly lighter than air at equal temperatures; cold nitrogen vapour is, however, denser than atmospheric air.
- Liquid nitrogen is odourless, colourless and boils at -195.8°C . One volume of liquid nitrogen gives approximately 700 volumes of gas at ambient conditions.
- Nitrogen is not flammable. It is chemically inert, except at high temperatures and pressures. Its volume concentration in air is 78%.
- Liquid and cold gaseous nitrogen can cause severe burns or frostbite when in contact with the skin or respiratory tract.
- Gaseous and liquid nitrogen is non-corrosive.
- Nitrogen does not support life and acts as an asphyxiant.
- Nitrogen is intrinsically non-toxic.

Fire and explosion hazards

Gaseous and liquid nitrogen are non-flammable and do not, themselves, constitute a fire or explosion risk. However, both gaseous and liquid nitrogen are normally stored under pressure and the storage vessels whether gas cylinders or liquid tanks, should not be located in areas where there is a high risk of fire or where they may normally be exposed to excessive heat.

Health hazards

Asphyxia

Nitrogen, although non-toxic, can constitute an asphyxiation hazard through the displacement of the oxygen in the atmosphere. Nitrogen gas or oxygen depletion is not detectable by the normal human senses.

Oxygen is necessary to support life and its volume concentration in the atmosphere is 21%. At normal atmospheric pressure persons may be exposed to oxygen concentrations of 18% or even less, without adverse effects. However, the response of individuals to oxygen deprivation varies appreciably. The minimum oxygen content of breathing atmospheres should be 18% by volume but to ensure a wider margin of operational safety it is recommended that persons are not exposed to atmospheres in which the oxygen concentration is, or may become, less than 20% by volume.

Symptoms of oxygen deprivation, such as increased pulse and rate of breathing, fatigue, and abnormal perceptions or responses, may be apparent at an oxygen concentration of 16%.

Permanent brain damage or death may arise from breathing atmospheres containing less than 10% oxygen. Initial symptoms will include nausea, vomiting and gasping respiration. Persons exposed to such atmospheres may be unable to help themselves or warn others of their predicament. The symptoms are an inadequate warning of the hazard.



DANGER

Breathing a pure nitrogen atmosphere will lead to danger of suffocation and death. Exposure to an oxygen deficient atmosphere may cause the following symptoms: dizziness, salivation, nausea, vomiting, loss of mobility/consciousness.

Cold burns

Liquid and cold nitrogen vapours or gases can produce effects on the skin similar to a burn. Naked parts of the body coming into contact with un-insulated parts of equipment may also stick fast (as all available moisture is frozen) and the flesh may be torn on removal.

Frostbite

Severe or prolonged exposure to cold nitrogen vapour or gases can cause frostbite. Local pain usually gives warning of freezing but sometimes no pain is experienced. Frozen tissues are painless and appear waxy with a pallid yellowish colour. Thawing of the frozen tissues can cause intensive pain. Shock may also occur if the burns are at all extensive.

Effect of cold on lungs

Prolonged breathing of extremely cold atmospheres may damage the lungs.

Hypothermia

Low environmental temperatures can cause hypothermia and all persons at risk should wear warm clothing. Hypothermia is possible in any environmental temperature below 10°C but susceptibility depends on time, temperature and the individual. Older persons are more likely to be affected. Individuals suffering from hypothermia may find that their physical and mental reactions are adversely affected.

Precautions

Operations and maintenance

It is essential that operations involving the use of gaseous or liquid nitrogen particularly where large quantities are used are conducted in well-ventilated areas to prevent the formation of oxygen deficient atmospheres.

Ideally, nitrogen should be vented into the open air well away from areas frequented by personnel. It should never be released or vented into enclosed areas or buildings where the ventilation is inadequate. Cold nitrogen vapours are denser than air and can accumulate in low lying areas such as pits and trenches.

Where large spills of liquid nitrogen occur, a fog forms in the vicinity of the spill caused by the condensation of water vapour in the surrounding air. The fog, in addition to severely reducing visibility may contain oxygen concentrations appreciably lower than that of the air presenting a local asphyxiation hazard.

Personnel protection

Persons handling equipment in service with liquid nitrogen should wear protective face shields, loose fitting gauntlets and safety footwear.

Emergencies

In the event of an accident or emergency the instructions below should be implemented without delay.

Asphyxiation

Persons showing symptoms of oxygen deprivation should be moved immediately to a normal atmosphere. Persons who are unconscious or not breathing must receive immediate first aid. Medical assistance should be summoned without delay. First aid measures included inspection of the victim's airway for obstruction, artificial respiration and simultaneous administration of oxygen. These procedures should only be carried out by a trained first aid staff. The victim should be kept warm and resting.

It is important that the personnel carrying out rescue operations should minimise the risk to themselves.

Treatment of cold burns and frostbite

Cold burns should receive medical attention as quickly as possible. However, such injuries are not an everyday occurrence and doctors, hospital staff or works first aid personnel may not be aware of the basic methods of treatment. The following notes describe the first aid treatment and recommended advice for further treatment to be given by a medical practitioner or a hospital.

First Aid

In severe cases summon medical attention immediately. Flush affected areas of skin with copious quantities of tepid water to reduce freezing of tissue. Loosen any clothing that may restrict blood circulation. Move the victim to a warm place but not to a hot environment and do not apply direct heat to the affected parts. Every effort should be made to protect frozen parts from infection and further injury. Dry, sterilised bulky dressings may be used but should not be applied so tightly that blood circulation is restricted.

Treatment by Medical Practitioner or Hospital

1. Remove any clothing that may constrict the circulation to the frozen area. Remove patient to sick bay or hospital.
2. Immediately place the part of the body exposed to the cryogenic material in a water bath which has a temperature of not less than 40°C but no more than 45°C. Never use dry heat or hot water. Temperatures in excess of 45°C will superimpose a burn upon the frozen tissue.
3. If there has been a massive exposure to the super cooled material so that the general body temperature is depressed, the patient must be re-warmed gradually. Shock may occur during re-warming, especially if this is rapid.

4. Frozen tissues are painless and appear waxy with a pallid yellowish colour. They become painful, swollen and very prone to infection when thawed. Therefore, do not re-warm rapidly if the accident occurs in the field and the patient cannot be transported to hospital immediately. Thawing may take from 15-60 minutes and should be continued until the blue, pale colour of the skin turns to pink or red. Morphine, or some potent analgesic, is required to control the pain during thawing and should be administered under professional medical supervision.
5. If the frozen part of the body has thawed by the time medical attention has been obtained, do not re-warm. Under these circumstances cover the area with dry sterile dressings with a large bulky protective covering.
6. Administer a tetanus booster after hospitalisation.

Hypothermia

Persons suspected to be suffering from hypothermia should be wrapped in blankets and moved to a warm place. Slow restoration of temperature is necessary and forms of locally applied heat should not be used. Summon medical attention.

Liquid nitrogen spillage

If large spills of liquid nitrogen spillage occur, large quantities of water should be used to increase the rate of liquid vaporisation.

APPENDIX 6 THE AUTOFILL (AUTOMATED LN2 REFILL)

INTRODUCTION

Oxford Cryosystems has an optional autofill system which can be purchased with the Cryostream or later be retrofitted. The heart of the system consists of a capacitance based Liquid Level Sensor connected to the 1000 Series Gas Supply Module. These two components together monitor the level of liquid within the Dewar Vessel. The Controller is also able to activate a solenoid valve to control the flow of liquid nitrogen from the self-pressurised Liquid Nitrogen Storage Vessel to the 60 Litre Cryostream Dewar Vessel.



SAFETY NOTES

The mishandling and misuse of liquid nitrogen and nitrogen gas can lead to equipment damage or injury. Please ensure you:

- have consulted your local Safety Officer before beginning
- are qualified to set up the equipment
- have taken the appropriate health and safety precautions for the handling of liquid nitrogen
- are wearing the appropriate protective clothing when handling liquid nitrogen







MAINTENANCE NOTES

- **Regularly clean the Cryostream Dewar** to prevent ice buildup inside the vessel and around its neck. Ice accumulation can obstruct liquid nitrogen flow and affect system performance.
- **Frequently remove and dry the Liquid Level Sensor** to prevent ice contamination, which may impair its accuracy and reliability (see *Maintenance*). If the sensor is exposed to atmospheric moisture, it must be warmed to room temperature and purged with dry air from the Dry Air Unit to restore proper function.
- **Never let the Dewar run dry.** As it is open and unpressurised, an empty vessel draws in moist air, which freezes on internal cold surfaces. This can contaminate the sensor, leading to false level readings, and may block the neck of the Dewar—potentially disabling the Autofill system and interrupting Cryostream operation.

These preventive steps are essential to maintain accurate sensor performance and ensure uninterrupted, reliable cooling.

COMPONENTS OF THE AUTOFILL

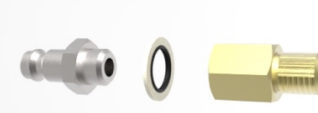
<ul style="list-style-type: none">• Liquid Nitrogen Level Sensor and Oscillator Head Assembly (LSA) low pressure relief valve and associated cables	
<ul style="list-style-type: none">• T-Piece with Pressure Relief Valve, 24V Cryogenic Solenoid Valve and cable	
<ul style="list-style-type: none">• Braided Transfer Line	
<ul style="list-style-type: none">• Cryostream Dewar Neck Fitting	
<ul style="list-style-type: none">• Level Sensor Brass Adapter and Fitting for Drying Cycle	

Liquid Nitrogen Level Sensor and Oscillator Head Assembly with Integrated Cable (LSA)



WARNING

The LSA is made up of the Oscillator control box and the sensor. These items are calibrated as a pair and the function of the Autofill can only be relied upon to provide safe operation if they remain operating as the calibrated pair supplied by Oxford Cryosystems. In the unlikely event of LSA failure then the pair would need to be swapped or replaced, not the individual components.

The liquid level sensor (LSA) is manufactured from 10mm diameter stainless steel tubing and is 770mm in length. The sensor is pre-calibrated to the type of Dewar supplied with the Cryostream and designed to be fitted to the Oscillator Controller box using the bayonet connector on the base of the box. It comes pre-assembled to a T-piece containing a low pressure relief valve and connects to the ½” NPT outlet on the side of the Dewar.



Figure A9 Completed autofill assembly.

T-Piece with Pressure Relief Valve, 24V Cryogenic Solenoid Valve

A pressure relief valve is located on a short section of pipe between the solenoid valve and the self-pressurised storage vessel connection. The short pipe section has a female swivel flare connection on one end for easy connection to the self-pressurised storage vessel outlet valve and a male 3/8” NPT male thread on the other end for attaching to the solenoid valve. The relief valve is on a gooseneck configuration to direct any cold gas downward and has a set pressure of 3 bar. The 24V cryogenic liquid solenoid valve is operated in conjunction with the 1000 Series Temperature Controller to maintain the desired cryogenic liquid level. The power cord supplied with the control valve is plugged directly into the temperature controller at the port marked **Auto Fill Valve**. When the power receptacle is activated the solenoid valve opens and allows liquid to flow from a pressurised nitrogen reservoir to the Dewar.

Braided Transfer line

The liquid nitrogen transfer line is made from stainless steel hose and has been designed for the transfer of liquid nitrogen and should only be used on this specific application. The transfer line has an overall length of 1.5m. One end is designed to fit to the outlet side of the solenoid and is 3/8" NPT male. The other end is a 3/8" BSP swivel flare to fit to the Dewar neck fitting fill port with an adapter.

CALIBRATION AND SET POINTS

The Autofill System integrated into the 1000 Gas Supply Module has been pre-calibrated. The LSA has two pre-designated Refill and Stop Points on the sensor. These have been optimised to allow the Cryostream to function properly and to maximise the time between refills to best utilise the liquid nitrogen in the Storage vessel.

The Refill level is at 20% of active area of the sensor and the lower level at which the filling is triggered via the activation of the solenoid valve and the filling of the vessel commences.

The Stop level is 80% of active area of the sensor and is the higher level at which the filling is stopped via the deactivation of the solenoid valve and the filling of the vessel stops.

These points do not necessarily correspond to the capacity of the Dewar but are set to ensure that the Cryostream is always running at its optimum and that the Dewar cannot overflow. The amount of liquid between Refill and Stop is approximately 36 litres of liquid. This is about 60 hours of running at 5l/minute between refills.

The fill and stop levels can be adjusted between 20 – 40% and 60 – 80%.

BEFORE GETTING STARTED

Before setting up and using the automatic refill system, it is important to check a few things, first.

1. The Autofill system is designed to measure and controller the flow of liquid nitrogen from a self-pressurised liquid nitrogen storage vessel. This vessel requires two important features to ensure straightforward set up and use with the Autofill system and the Cryostream.
 - a. The gooseneck assembly on the Autofill is supplied with a 1/2" BSPP female fitting as standard. Therefore, the storage vessel's outlet fitting should be (or adapted to) a 1/2" BSPP male coupling. (On certain configurations a 3/4" JIC female fitting is also supplied for the gooseneck assembly – this fitting can be found in the accessories bag).
 - b. A maximum storage pressure of 1-2 bar (15-30 psi). NOTE: If the storage vessel has a pressure higher than this may result in the Autofill behaving outside specification.
2. The distance from the Self-pressurised Storage Vessel to the Cryostream Dewar is set by the length of the braided transfer line. The distance from the Cryostream Dewar to the cold stream position is governed by the length of the Cryostream transfer line and the angle of the Coldhead, so make sure these dimensions are taken into account before setting up.
3. The 1000 Series Gas Supply Module is connected to both the LSA installed in the Cryostream Dewar and also the solenoid valve at the self-pressurised storage vessel. This puts a constraint of the distances from the Controller to these vessels.

- a. The default maximum distance from the 1000 Series Gas Supply Module to the LSA is 5 metres. A 5 metre extension cable is also provided, if this length cannot be limited to 5 metres.
- b. The default maximum distance from the 1000 Series Gas Supply Module to the solenoid valve is 5 metres. A 5 metre extension cable is also provided.

SETTING UP

Fit the system together as shown in the diagram below. Here are some helpful guidelines

- It is recommended that you start at the Self-pressurised Storage Vessel. You may find the system comes partly assembled from Oxford Cryosystems.
- When assembling the Cryostream Dewar Neck Fitting for the Cryostream Dewar, it is important that the correct connection is fitted into the correct port. This should be self-explanatory as each port is sized accordingly.

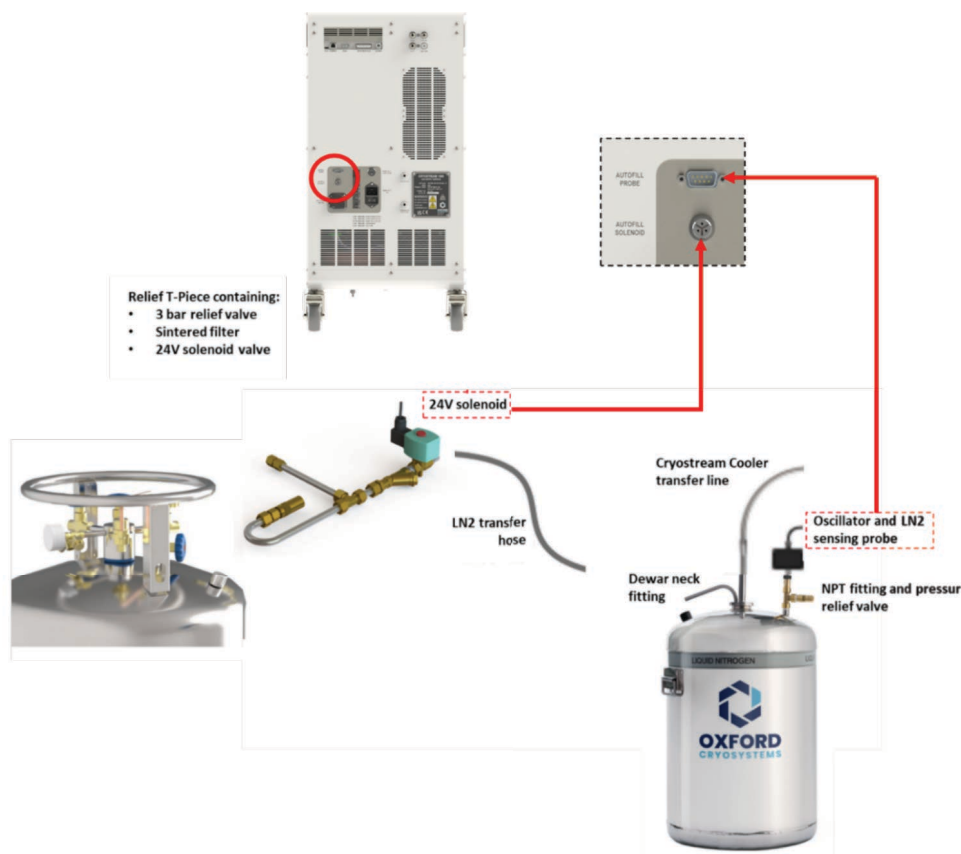

Figure A10 Schematic of autofill assembly



WARNING

It is very important that the Relief Cross with pressure relief valve, 24V solenoid valve and decanting valve assembly is fitted the right way up. The valves WILL NOT OPERATE CORRECTLY IF INSTALLED UPSIDE DOWN. Use the image above to determine the correct orientation. Do not disassemble this Relief Cross.

- When fitting the Cryostream transfer line into the Dewar Neck Fitting, make sure the rigid leg section of the Cryostream is about 5 cm off the bottom of the vessel. This is very important as:
 1. It prevents the Cryostream drawing up unwanted ice from the bottom of the Dewar
 2. The refilling set points are based on the Cryostream drawing liquid from this point.
- The final connection on the Neck Fitting is a 3/8" male brass fitting and is for the Liquid Nitrogen Transfer Line.
- The separate 1/2" port on the Cryostream Dewar is for the LSA. The LSA is fitted into a T-piece which screws onto this port. The LSA will be delivered preassembled and clamped into the T-piece. However, it is very important that the LSA is set at the correct height in the Dewar. **If the LSA is set too high in the Dewar this may result in the Dewar overflowing.**
 1. Unscrew the knurled nut holding the LSA in place on the T-piece and slide the LSA down until it touches the bottom of the Dewar.
 2. Lift the LSA up approximately 5mm from the bottom of the Dewar.
 3. Tighten the knurled nut to clamp the LSA the place. This is the correct set point for the LSA.

FEATURES

The Autofill system is designed to be self-managing and has many features to ensure its safe operation. Some of these include:

- Monitoring calibrated constants of the level probe to ensure they do not move from their predefined range.
- Monitoring the supply voltage to the electronics in the oscillator head to ensure safe operation.
- Checking for LSA contamination by measuring the voltage to the sensor.
- The cable to the solenoid valve is checked to make sure it is connected and energised correctly.
- During refilling, the liquid level is monitored to ensure it is changing at a reasonable rate. If the liquid level does not change, a fault will be reported.
- If the LSA is removed from the Dewar, a sudden drop in liquid level is detected and a fault is indicated.
- Regardless of the mode of the Autofill, the LSA will monitor the level of liquid in the Dewar vessel on a real-time continuous basis.

OPERATION



CAUTION

It is strongly recommended that the user ensure there is at least some liquid nitrogen in the Dewar before using the Cryostream and Autofill system. Relying on the Autofill system to fill a warm and empty Dewar may result in errors from both the Autofill system and, separately, the Cryostream itself. There is no possibility of damage, however, the Controller may find itself in a position where it needs to be restarted due to, for example, a time out or low flow error. See *Manual Filling*

The Autofill System is operated from the 1000 Gas Supply Module. The system will automatically detect the presence of the LSA and the solenoid valve. The controller will not allow the Autofill to control the level of liquid if the correct parts are not plugged in to it. Once the Autofill is connected up properly, the controller may be switched on.

Once the controller has been switched on, the Autofill element will take up to a further 60 seconds to complete its initialisation. It does this as it continues to make time-linked checks on the level of the liquid in the Dewar. Once the Autofill system has been detected, the Main screen will display an LN2 % indicator in the bottom right corner of the screen.

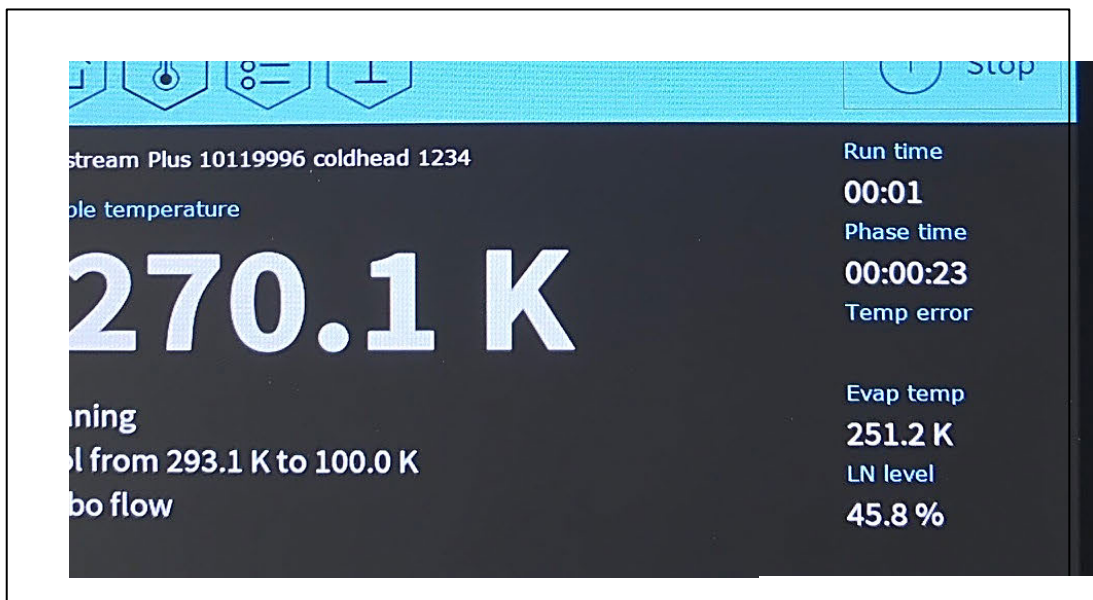

LN2 % indicator

Figure A11 Location on screen of liquid nitrogen level

A dedicated option will also appear within the Settings screen, which can be accessed via the Settings button and navigating via the Left / Right buttons to Autofill page.

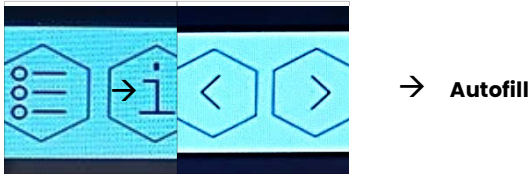

MENU LEVEL 1	MENU LEVEL 2	SELECTION
	Fill Mode	<ul style="list-style-type: none"> • Monitor • Autofill

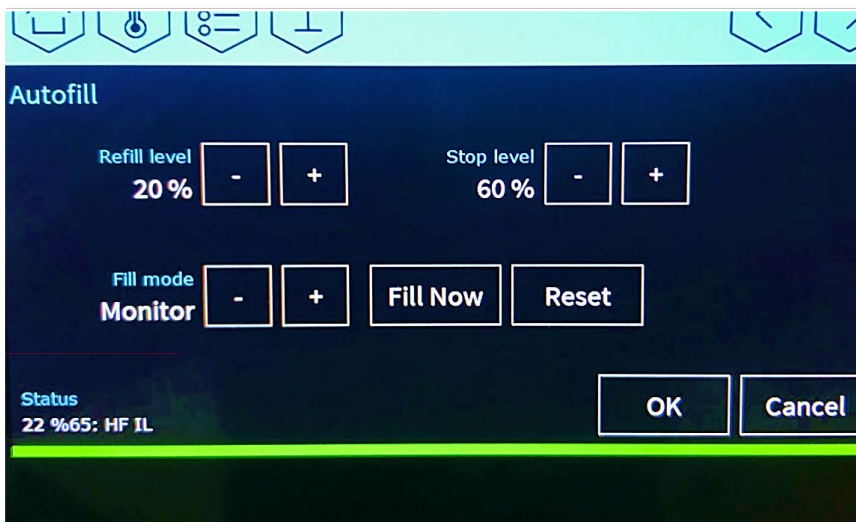

- 1) **Refill Level** - the level of liquid in the Dewar corresponding the level the refilling is activated.
- 2) **Stop Level** - the liquid level at which refilling is stopped.
- 3) **Fill mode.** The Autofill system has three modes of operation:

Auto	controller will monitor the level of liquid in the vessel and will trigger the solenoid valve to open when Refill level is reached and will close the solenoid valve when the Stop level is reached.

NOTE: When the controller and integrated Autofill have finished initialising, the Autofill will default to **Auto** mode. This feature is designed to allow the user to start the system promptly and to have the controller manage all features of the system without further user intervention. See *Quick Start Mode*.

Quick Start Mode

Once the controller is ready, the user is able to press the START button to Cool to 100K (or default). The Autofill system is in AUTO mode at this point. This means that it will control the flow of liquid at this stage under the following circumstances:

1. If there is a measurable amount of liquid in the Dewar (the blue bar should show this) and when the user presses START, the system will control the amount of liquid in the vessel. If this level is measurable AND below the Refill Level, the Autofill system will shortly initialise a fill, up to the Stop level where it will stop and will then continue in AUTO mode.
2. If there is no liquid in the Dewar (this is not recommended. See Caution Note above,) the Autofill will try to fill the vessel with liquid, however, a shutdown maybe caused to the controller due to a flow rate or time out error.

Manual Filling

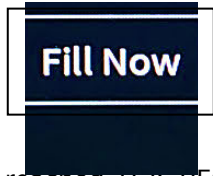

The user is able to manually fill the Dewar by pressing the **Fill** button on the Autofill Commands screen. This will activate the solenoid valve and allow the flow of liquid into the Dewar. The Fill button will change to a **Stop** button allowing the user to stop the fill. If the user chooses not to stop the fill, the filling will stop automatically once the Stop level is reached. IT IS RECOMMENDED THAT IF THE DEWAR IS EMPTY, IT SHOULD BE FILLED MANUALLY AT THE START OF EACH RUN.

Daily Filling

If the user would prefer for refilling to take place at a particular time on a daily basis, Daily Filling allows for scheduled refilling regardless of the level of liquid in the vessel. Once the Stop level is reached the system will stop filling.

Use the Up and Down arrows to select 'Daily' from the Autofill menu. If OK is pressed and the Delay is 0 hours, the system will fill the Dewar to the Stop point - but only once the Cryostream is running, and this will be followed by an automatic top-up 24 hours later. This process can be delayed to a later starting point by moving the slider bar to a delayed time in the future and then pressing OK. The Delay timer will only start when the Cryostream starts running. The Autofill will then refill 24 hours after the delayed time has elapsed.

Change Modes of Operation

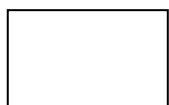

The user is able to change from Auto, Monitor or Timed by using the 'Up' and 'Down' arrows to change the mode in the yellow box. Once the mode of choice is selected, the user must press 'OK' to accept this selection. At this point, the controller will return to the Home screen.

Error Conditions

If a fault or error state is triggered, the Autofill element of the Cryostream may be reset to clear the fault **without** the need to stop or restart the Cryostream controller itself. This means the user's sample will remain unaffected in the Cryostream.

Some error conditions may be rectified and can then clear themselves, however, others require the user to reset the Autofill.

Errors that do not require resetting will result in the Autofill putting itself into a monitoring state until the error condition is cleared, and then the Autofill system will continue in Auto mode (if it was set to Auto mode prior to the error state).

Errors that can be cleared without resetting:

- Disconnected Level Sensor
- Disconnected solenoid valve
- If the Stop Level is exceeded by 5%
- Filling timeout – if the Dewar takes more than 45 minutes to fill, the solenoid will close.

Errors requiring resetting of Autofill:

- Liquid level does not change (liquid is not flowing into the Dewar).
- Rapid drop in measured liquid level (e.g.) by removing the Level Sensor from the Dewar).
-

Resetting Instructions

On the controller, navigate to the 'Set Autofill mode' screen and press the 'Reset' button. This DOES NOT stop the Cryostream, it simply restarts the Autofill program.

MAINTENANCE

The Autofill System requires a small amount of regular maintenance to prevent contamination from water in the LSA. With any nitrogen vessel, especially a vessel open to atmosphere, it is good practice to ensure the vessel is cleaned out and dried every month or two. This is very important if the Dewar is allowed to run dry as a cold Dewar will suck in atmospheric moisture. This will help prevent:

1. The Cryostream drawing up particles of ice and, potentially blocking.
2. Ice or condensation entering the LSA and causing a short circuit within the capacitance probe resulting in a misreading of the liquid level. Contamination of the LSA will result in the liquid level reading *higher* than the actual level which would be inconvenient to the user causing the system to refill at a lower level.
- 3.

To clean the Dewar vessel, empty it of any remaining liquid nitrogen and allow it to warm up. As liquid nitrogen vessels are insulated this can take some time (sometimes, days) so to accelerate this, feed the dry air tube from the Dry Air Unit into the vessel via the vent port and turn the flow up to maximum! This warmer air will help accelerate the warming of the vessel. Once the vessel has warmed up and any residual ice has melted, tip any water from the vessel out and continue to use the dry air to dry the inside surfaces of the vessel. This can also be done with a cloth on the end of a stick.

Level Sensor Drying Cycle

The LSA is a capacitance based measuring device with contains two tubes, one inside the other with a very small gap between them. Any water or ice that forms in this gap can cause the two elements to short together and give a misreading. If this is the case, the sensor needs to be carefully dried out.

The Sensor may be dried by following the steps below:

1. Removing the Probe Assembly from the Dewar and removing the Oscillator box from the top of the sensor for convenience.
2. Carefully unscrew the plastic cap from the end of the sensor. Ensure it is warm before attempting this.



3. Fit the Brass Adapter and 8mm push-in fitting provided, as illustrated in the image below, to the end of the sensor.

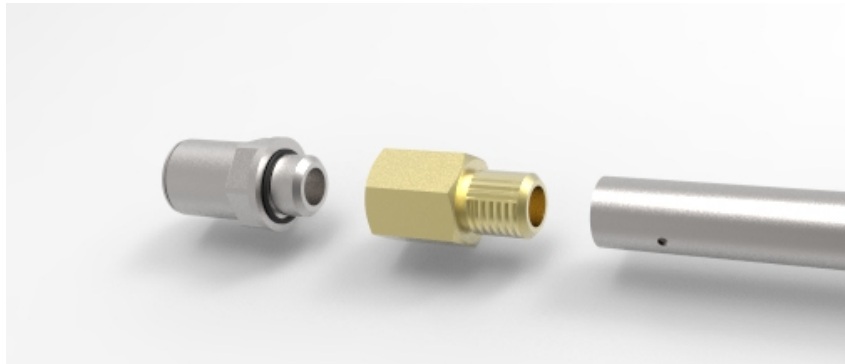

4. The dry air supply to the Cryostream may then be fitted to the end of the Level Sensor using the red 8mm tubing and, without adjusting the flow rate used for the Cryostream, the Level Sensor should be left to dry out for 30 minutes.
5. Once this cycle has been completed, the Brass Adapter and fitting should be removed from the sensor and the Plastic Cap refitted. The sensor can be reassembled to the Oscillator box and placed back into the Dewar.

AUTOFILL STATUS SCREEN FAULT CODES

If the Autofill system experiences a fault during operation, the message “Autofill Error” will be displayed on the screen. In order to access the error code, press the settings button and use the arrow keys to navigate to either the live diagnostics screen or relay board diagnostics screen using the arrow keys :

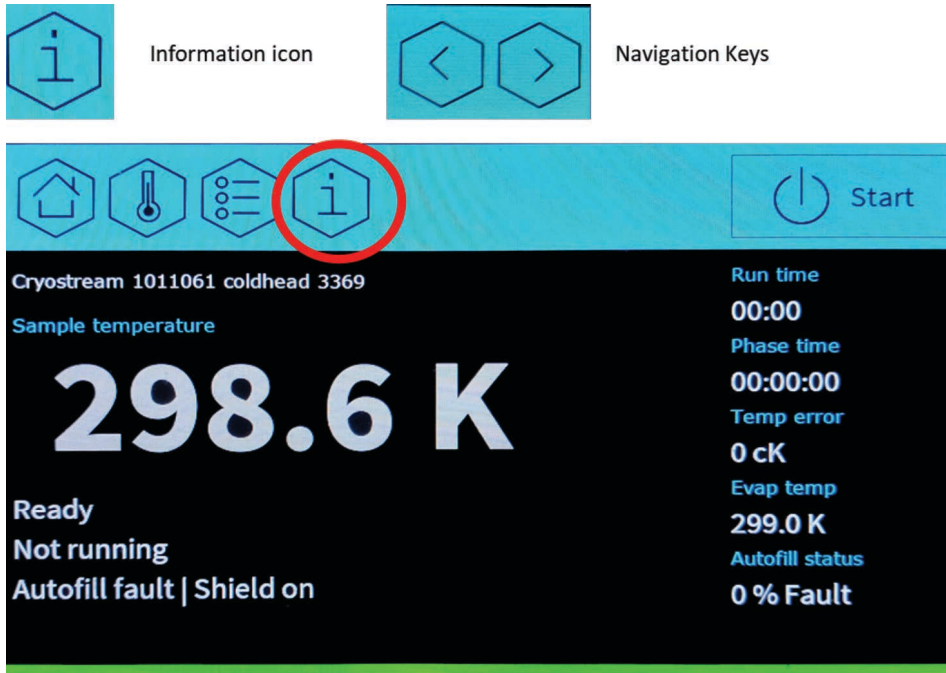
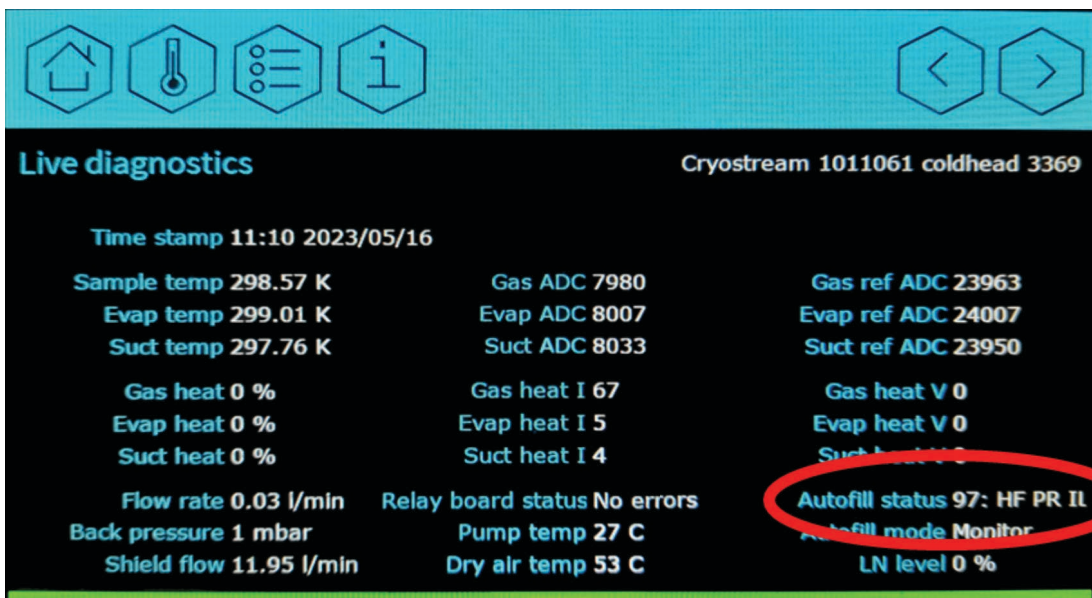

Figure A13 Accessing the information screen from the homescreen



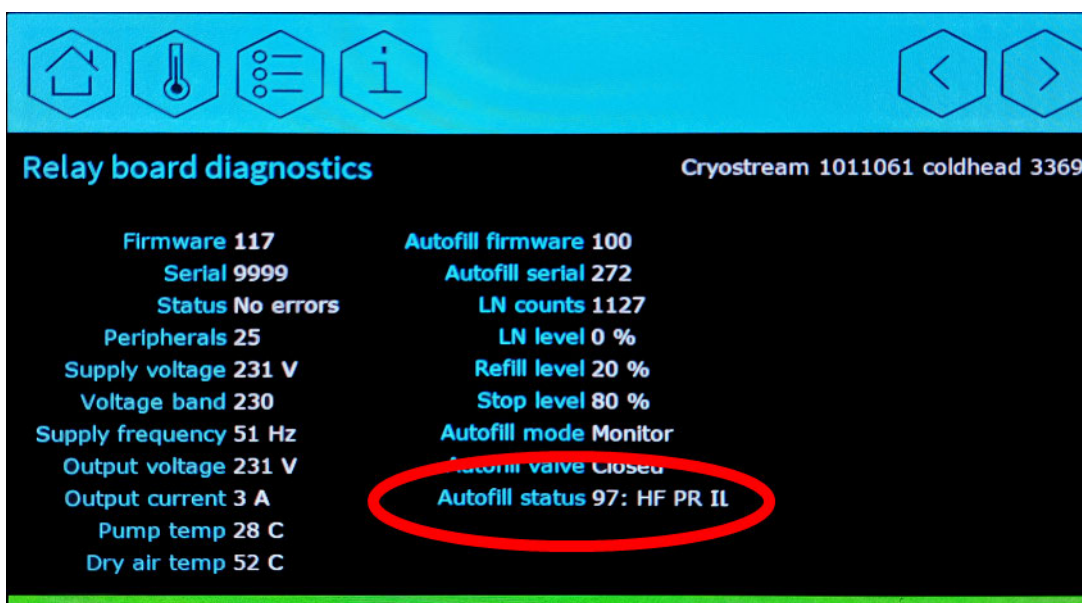

Figure A14 Accessing the autofill status from the live diagnostic screen or the Relay board diagnostic screen

On both of these screens is 'Autofill Status' (highlighted above) which gives letter codes. Each letter code has an error associated, please see the table on the following page for a list of errors.

Error Code	Description	Corrective Action
NC	Autofill head not calibrated	Check if the level probe is correctly connected to the Cryostream controller. If the problem persists contact Oxford Cryosystems Technical Support.
SV	Incorrect supply voltage	Level probe might be contaminated with moisture. Refer to the Maintenance section for instructions on drying out the probe.
RV	Incorrect reference voltage	Level probe might be contaminated with moisture. Refer to the Maintenance section for instructions on drying out the probe.
LC	Incorrect low calibration constant	Check if the level probe is correctly connected to the Cryostream controller. If the problem persists contact Oxford Cryosystems Technical Support.
HC	Incorrect high calibration constant	Check if the level probe is correctly connected to the Cryostream controller. If the problem persists contact Oxford Cryosystems Technical Support.
RL	Incorrect refill level	Check if the level probe is correctly connected to the Cryostream controller. If the problem persists contact Oxford Cryosystems Technical Support.

SL	Incorrect stop level	Check if the level probe is correctly connected to the Cryostream controller. If the problem persists contact Oxford Cryosystems Technical Support.
LN	Incorrect liquid nitrogen level	Level probe might be contaminated with moisture. Refer to the Maintenance section for instructions on drying out the probe.
PV	Incorrect probe voltage	Level probe might be contaminated with moisture. Refer to the Maintenance section for instructions on drying out the probe.
TE	Incorrect head temperature	Check if the level probe is correctly connected to the Cryostream controller. If the problem persists contact Oxford Cryosystems Technical Support.
OF	Oscillator fault	Level probe might be contaminated with moisture. Refer to the Maintenance section for instructions on drying out the probe.
CE	Head communication error	Check if the level probe is correctly connected to the Cryostream controller. If the problem persists contact Oxford Cryosystems Technical Support.
LE	Nitrogen level not rising during filling	Check if the pressurised Dewar contains any liquid nitrogen Check if the manual isolation valve is fully opened.
TO	Filling phase timeout	Check if the pressurised Dewar contains any liquid nitrogen Check if the manual isolation valve is fully opened.
PR	Probe removed from Dewar	The controller has registered a sudden change in liquid nitrogen level. Check the level probe and Dewar.
MF	Motherboard communication error	Check if the level probe is correctly connected to the Cryostream controller. If the problem persists contact Oxford Cryosystems Technical Support.
SF	Solenoid Fault	Contact Oxford Cryosystems Technical Support.
OF	High fill level limit exceeded	Level probe might be contaminated with moisture. Refer to the Maintenance section for instructions on drying out the probe.
HF	Head Failure	Check connection of head to the GSM. If problem persists contact Oxford Cryosystems technical support
IL	Incorrect Limits	Level probe might be contaminated with moisture. Refer to the Maintenance section for instructions on drying out the probe.



Declaration of Conformity of the Machinery

According to Directive 2006/42/EC, Annex II Part 1 A

Details of manufacturer or supplier

Oxford Cryosystems Ltd. : part of the Judges Scientific Plc. group of companies.

Full postal address including country of origin

Judges Scientific (Dublin) Ltd., 2nd Floor, 1-2 Victoria Buildings, Haddington Road, Dublin 4, D04 XN32, Ireland
Oxford Cryosystems Ltd., Hanborough House, Hanborough Business Park, Long Hanborough, OX29 8LH, United Kingdom

Description of product

Scientific instrumentation for N2 based sample cooling; consisting of 1000 Series Cryostream Cooler, 1000 Series Cryostream Plus, 1000 Series Cryostream Compact, 1000 Series Integrated Automatic Liquid Nitrogen Refill System

Name, type or model, batch or serial number

Name	Cryostream 1000 Series + Gas Supply Module	Model	1000 series Cryostream Cooler with Automatic Refill
Type	Sample Cooler	Serial Number	1011001

Standards used, including number, title, issue date and other relative documents

BS EN ISO 12100:2010 Safety of machinery – General principles for design - Risk assessment and risk reduction
BS EN ISO 14120:2015 Safety of machinery – Guards – General requirements for the design and construction of fixed and movable guards
BS EN ISO 13857:2019 Safety of machinery – Safety distances to prevent hazard zones being reached by upper and lower limbs

Name of authorised representative Anthony Cooper
Position of authorised representative Managing Director

The Technical Construction File required by this Directive is maintained by:

Name James Parsons

I declare that I will maintain the Technical Construction file and ensure its full and compliant content. The technical documents have been compiled according to Annex VII Chapter B and we commit to deliver these documents to a Market Surveillance Authority on demand.

Signature of representative:

Date: 24th Oct 2022

Declaration

We hereby declare that the products mentioned above comply with the requirements of the Machinery Directive (2006/42/EC), EMC Directive (2014/30/EU), and Low Voltage Directive (2014/35/EU).

Signature of authorised representative:

Date: 24th Oct 2022

Place of issue: Oxford, UK



Declaration of Conformity of the Machinery

According to The Supply of Machinery (Safety) Regulations 2008 (as amended in 2011) , Annex II Part 1 A

Details of manufacturer or supplier

Oxford Cryosystems Ltd. : part of the Judges Scientific Plc. group of companies.

Full postal address including country of origin

Judges Scientific (Dublin) Ltd., 2nd Floor, 1-2 Victoria Buildings, Haddington Road, Dublin 4, D04 XN32, Ireland
Oxford Cryosystems Ltd., Hanborough House, Hanborough Business Park, Long Hanborough, OX29 8LH, United Kingdom

Description of product

Scientific instrumentation for N2 based sample cooling; consisting of 1000 Series Cryostream Cooler, 1000 Series Cryostream Plus, 1000 Series Cryostream Compact, 1000 Series Integrated Automatic Liquid Nitrogen Refill System

Name, type or model, batch or serial number

Name	Cryostream 1000 Series + Gas Supply Module	Model	1000 series Cryostream Cooler with Automatic Refill
Type	Sample Cooler	Serial Number	1011001

Standards used, including number, title, issue date and other relative documents

BS EN ISO 12100:2010 Safety of machinery – General principles for design - Risk assessment and risk reduction
BS EN ISO 14120:2015 Safety of machinery – Guards – General requirements for the design and construction of fixed and movable guards
BS EN ISO 13857:2019 Safety of machinery – Safety distances to prevent hazard zones being reached by upper and lower limbs

Name of authorised representative Anthony Cooper
Position of authorised representative Managing Director

The Technical Construction File required by this Directive is maintained by:

Name James Parsons

I declare that I will maintain the Technical Construction file and ensure its full and compliant content. The technical documents have been compiled according to Annex VII Chapter B and we commit to deliver these documents to a Market Surveillance Authority on demand.

Signature of representative:

Date: 24th Oct 2022

Declaration

We hereby declare that the products mentioned above comply with the requirements of The Supply of Machinery (Safety) Regulations 2008 (as amended in 2011), The Electromagnetic Compatibility Regulations 2016, and The Electrical Equipment (Safety) Regulations 2016.

Signature of authorised representative:

Date: 24th Oct 2022

Place of issue: Oxford, UK



SUPPORT@OXCRYO.COM